

COLLECTION



**ROSSIGNOL**<sup>®</sup>  
**PRO**

**rossignol.fr**

French manufacturer of solutions for Waste Sorting, Urban Furniture and Hygiene Equipment.

# editorial

**1896**, date of creation of the company, which has industrialised throughout its history and which is now a major player in selective sorting, street furniture and sanitary equipment.

**100** employees work everyday in our factory in Mayenne (Western France), to contribute their know-how to design, produce and market innovative high-quality "Made in France" products.

**20 000 m<sup>2</sup>** logistics platform assuring delivery of your orders to France and abroad.

**1407** solutions destined for professional use regrouping our best-sellers for selective sorting, street furniture and hygiene equipment. In the 2024 catalogue you will find our range of responsible and ecological products.

**100%** recyclable steel is used in the production of our litter bins, street furniture, ashtrays, dispensers and waste bins.

**2021**, date on which we obtained the Guaranteed French Origin certification. The aim of this commitment is to provide clear and transparent information on the origin of our products. As we are committed to respecting our planet, this action is perfectly in line with the environmental approach we wish to adopt.

**+ 2000** customers with whom we are proud to have had a long partnership for many years and who trust us to help them with their interior and exterior design projects. Our values are your values, and it is by continuing to work together to offer design solutions that respect our planet which we'll be able to achieve the greatest possible results.

Eric Fayol

Sales & Marketing Director

## OUR **CSR**\* COMMITMENT

### All responsible, all committed

Since 1896, Rossignol, French company based in Montsurs (Western France), which designs and manufactures products, has always maintained an industrial activity in the same location as where it was founded.

Rossignol, now wants to build on this expertise, in order to broaden our various product offerings: selective sorting solution, street furniture and hygiene equipment.

This significant know-how enables a high level of responsiveness to all requests, not to mention the attentiveness and competence of our sales and technical teams.

This recognition by our customers and users, over the last 125 years, must be maintained based on commitment to sustainable development.

In 2022, Rossignol conducted its first materials analysis. The preparation of this document marks the company's new CSR approach. Rossignol, as a French economic player, contributes to societal issues and along with its stakeholders has identified 3 areas in which it wishes to become a leader.



#### ENVIRONMENT

- E1 > Energy savings**
- E2 > Adaptation to climate change (water, heat, ...)**
- E3 > Waste Management**
- E4 > Product Quality**



#### HUMAN

- H1 > Safety and Working Conditions**
- H2 > Involvement and awareness of employees**
- H3 > Well-being at work**
- H4 > Skills development and training**



#### SUSTAINABILITY

- P1 > Communication Internal-External**
- P2 > Eco-design**
- P3 > Responsible Purchasing**

# The best solutions

## Made in France

ROSSIGNOL promotes Made in France and thus helps maintain jobs, supports companies and the national economy whilst preserving local know-how.



## Product solutions for every application

ROSSIGNOL can help you equip all your premises with quality products that reflect its know-how and expertise.

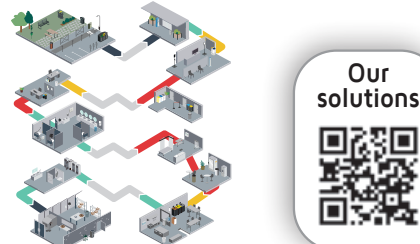

## Guaranteed French Origin certification

With this certification ROSSIGNOL enhances the value of its production and ensures the traceability of its products by giving you a clear and objective indication of their origin.



## Stand out with made-to-measure products

ROSSIGNOL is here to help you with your projects:

- Tailor-made design,
- Addition of options,
- Customisation (colour, branding, logo, etc)



## Installation Service

ROSSIGNOL offers a 5-step turnkey installation solution for selective sorting and street furniture equipment (Currently only available in France)



## Customise your products according to your desires

ROSSIGNOL helps you stand out. See our colour chart (pg.8). A large choice of standard ROSSIGNOL colours or specific colours.



# and services by **ROSSIGNOL**<sup>®</sup>

PRO

## Connected solutions

ROSSIGNOL makes it easier for you to manage your collections remotely by monitoring the level of your bins in real time, optimising your rounds and reducing your costs.



Our solutions



## Give your foodwaste a second life

ROSSIGNOL is here to answer your questions regarding foodwaste and offers you solutions to improve the quality of sorting and recycling this waste



Our solutions



## Together, let's recycle our waste

ROSSIGNOL complies with the regulatory requirements for selective sorting and waste collection with recycling bins installed in the administrative and production departments.

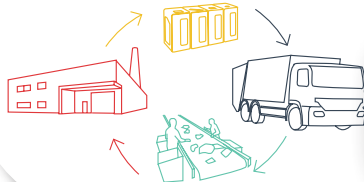

## An Eco-Responsible Company

ROSSIGNOL is building, step by step, a dynamic approach aimed at respecting the environment and producing sustainably.



## Recycled Products

For the good of our planet, ROSSIGNOL has broadened its eco-responsible product base, made from recycled plastic or aseptic packaging.



Our solutions



## Regulations adapted to each situation

ROSSIGNOL keeps you informed about regulatory standards and certifications. Find out more on pages 108 to 110



# Each space has its own product solutions

Waste sorting

Urban Furniture

## OUTDOOR FURNITURE 1

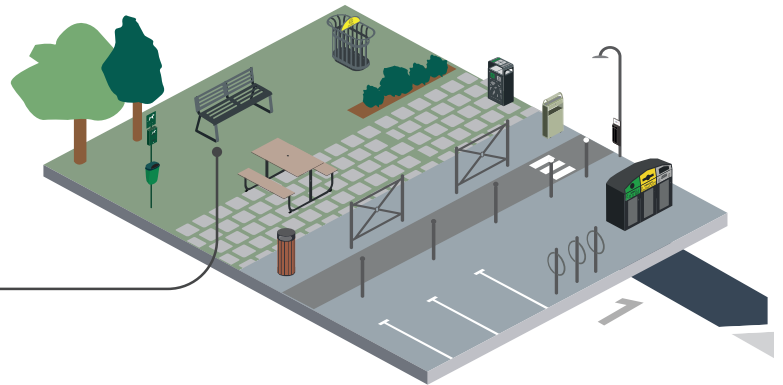
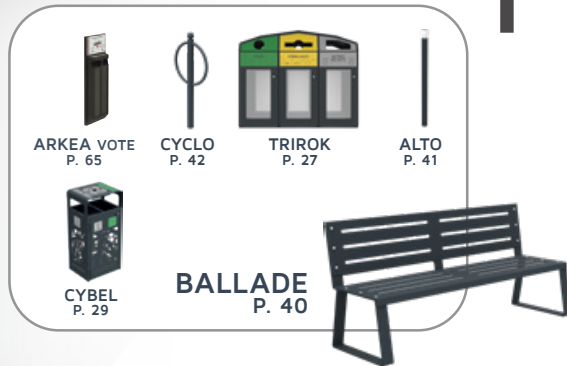

## OFFICES/ MEETING ROOMS 5

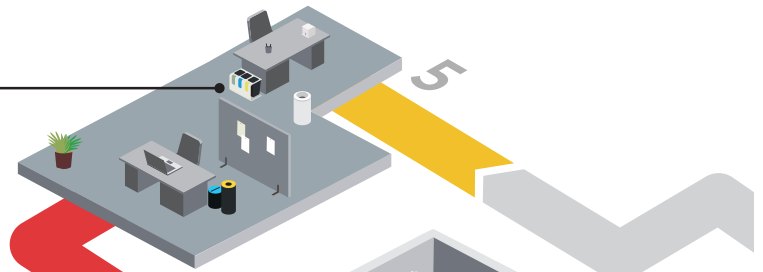

## SANITARY FACILITIES 6



## CLOAKROOMS/SHOWERS 10

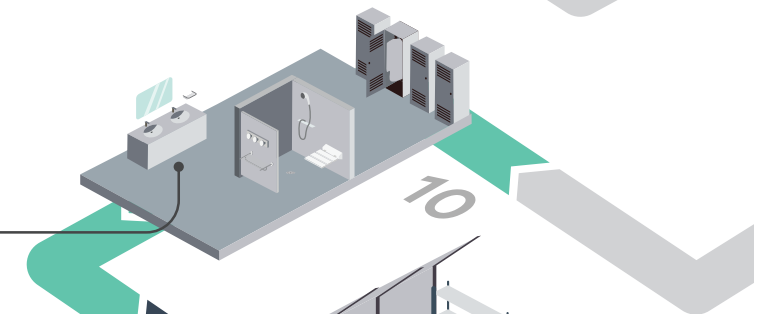
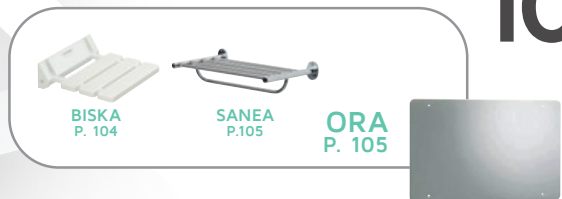

## WORKSHOPS/PRODUCTION 11



Rossignol helps you equip and maintain your premises with high-quality products that reflect our know-how and expertise.

Indoor

Hygiene

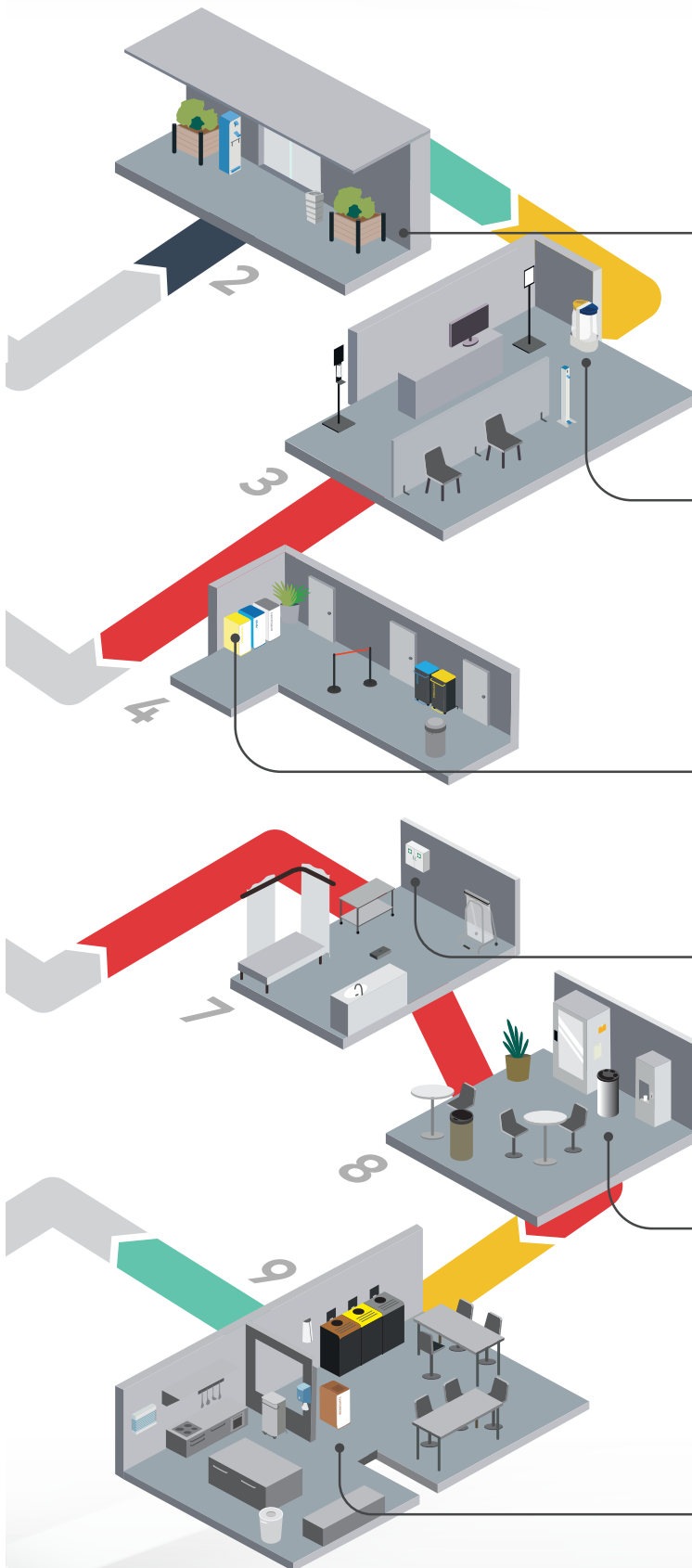

## 2 LOBBIES AND PORCHES



**VIBRATO**  
P. 38



**CUBAGEL**  
P. 90



**ARES**  
P. 67

## 3 RECEPTION AREAS



**CITWIN**  
P. 19



**INDIK**  
P. 72



**SANIMAINS**  
P. 90

## 4 CORRIDORS



**CUBATRI**  
P. 10



**NOMADE**  
P. 17



**PACEO**  
P. 72

## 7 INFIRMARY



**CLINIX**  
P. 81



**CLINABOX**  
P. 82



**HERMIX**  
P. 80

## 8 BREAK AREAS



**MULTIGOB**  
P. 75



**HANDTOUCH**  
P. 74

## 9 CATERING/KITCHENS



**CUBATRI FOODWASTE**  
P. 22



**PRATIK**  
P. 25



**ALITRI**  
P. 21



**CLARA**  
P. 88



**KILEO**  
P. 107

# French Regulation adapted to each situation

More details about the regulations can be found on pages 108 to 110



## AGEC LAW

### Circular economy and responsible supply:

Less waste generation, better sorting, better collection, more reuse and recycling.



## FOODWASTE

### Waste sorting :

In view of the 2024 law, think about sorting food waste at source!



## WASTE SORTING

### Waste recycling and recovery:

Sorting is becoming simple and effective for our planet because every little bit helps!



## VERMIN CONTROL

### Public health:

Avoid accumulation of waste and take necessary measures to control the spread of vermin.



## DOG HYGIENE

### Cleanliness of public places and pathways:

Do the right thing by picking up your dog waste.



## VIGIPIRATE

### Prevention and Protection :

Take appropriate protective measures by installing products where the content is visible.



## CONTACT WITH FOODSTUFFS

### Consumer protection:

Avoid the risk of toxicity or alteration of taste and quality of foodstuffs/ beverages by using appropriate food industry approved containers.



## HACCP

### Food safety in the food and beverage industry:

Ensure and control food safety to prevent hygiene hazards.



## ANTI-SMOKING LAW

### Cleanliness of our public and common areas:

Think about equipping your outdoor spaces!



## PRM

### Autonomy and Accessibility :

Install equipment facilitating access for PRM (People of Reduced Mobility).



## FIRST AID

### Health & safety at work:

Install first aid equipment adapted to the nature of the risks and ensure it is easily accessible.



## BLOOD WASTE

### Feminine hygiene:

Equip your toilet cubicles reserved for women with a receptacle for sanitary towels.





# Summary



Waste  
sorting

9



Urban  
furniture

37



Indoor

69



Hygiene

83



# Dare to go BOLD with colour!

ROSSIGNOL offers a large selection of standard colours and adapts to your visual identity

Smooth gloss					Smooth matt
 Sulphur yellow 1016 smooth gloss	 Colza Yellow 1021 smooth gloss	 Signal violet 4008 smooth gloss	 Ultramarine blue 5002 smooth gloss	 Light blue 5015 smooth gloss	 Pastel blue 5024 smooth matt
 Olive green 6003 smooth gloss	 Moss green 6005 smooth gloss	 Yellow green 6018 smooth gloss	 Mint green 6029 smooth gloss	 Cement grey 7033 smooth gloss	 Green blue 5001 smooth matt
 Brown 8001 smooth gloss	 Alu grey 9006 smooth gloss	 Light grey 9022 smooth gloss	 Traffic white 9016 smooth gloss	 Traffic red 3020 smooth gloss	 Manganese grey smooth matt
Textured matt					
 Anthracite grey 7016 textured matt		 Corten effect textured matt		 Grey beige 1019 textured matt	
				 Olive grey 7002 textured matt	

# Dare to go BOLD with different materials!

Choose from 4 different materials to suit your requirements

 Recycled aseptic packaging	 Wood	 HPL compact laminate	 Concrete
--	---	--	---

# Dare to be different!

Together let's design your projects (specific design, materials, customised colours ....)



Products neither taken back nor exchanged.  
\* Subject to estimate. Lead time of 5 to 8 weeks from receipt of order.



# Waste sorting



Waste sorting Indoor Bin

# Cubatri



Discover our Installation Service (p2)

2 colour options for the facades:  
White or Manganese grey

## SELECTING THE BEST OPTIONS WHEN CHOOSING THE CUBATRI MODULAR BIN



SEE Page 12

75L - 90L

Sack holder on a sliding rail

Facades with or without windows

With or without castors

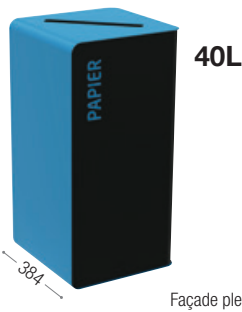

SEE Page 13

40L - 65L

Inner bucket

Windowless facades

Without castors

### 100% CUSTOMISABLE CUBATRI STATION ON REQUEST

- Customised opening
- Change of colour
- Addition of Braille
- Modification of signage
- Addition of foreign language
- Addition of logo or pictogram



Example of a Recycling station in various languages

FOR CONNECTED SOLUTIONS - CONTACT US





Waste sorting Indoor Bin



# Cubatri

75L - 90L

Sack holder on a sliding rail

Facades with or without windows

With or without castors



ENABLES THE VISUALISATION OF WASTE. FUNCTIONAL, MOBILE 360° ROTATION



90L "Vigipirate" anti-terrorism white front with castors



75L Manganese grey front

## CUBATRI

### WASTE SORTING BIN WITH SACK HOLDER ON A SLIDING RAIL - 75L AND 90L

- Anti-UV powder coated steel
- Integrated sack holder on a sliding rail
- Push/pull opening system thanks to its mechanical latch\*\*\*
- 4 adjustable plastic feet for uneven floors
- Waste identification on the door
- **"Vigipirate" version:** 4 impact resistant, transparent polycarbonate panels
- **Version with "castors":** 4 swivel castors Ø50 mm: 2 with brake + 2 without brake
- **"Confidential papers" version:** Locking system with flat key lock Secured rectangular slot 230x15mm with deflector

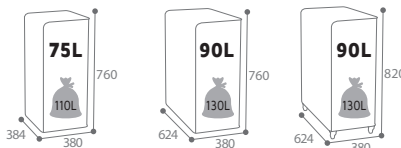

	75L		90L		90L with castors		90L VIGIPIRATE	90L VIGIPIRATE with castors
	with lock	without lock	with lock	without lock	with lock	without lock	without lock	without lock
<b>MANGANESE GREY front</b>								
Papier - Sky blue RAL 5015	55781	-	55421	-	54823	-	55587	54803
Plastique - Colza yellow RAL 1021	55782	-	55422	-	54824	-	55588	54804
Métal - Traffic red RAL 3020	55783	-	55419	-	54821	-	55585	54801
Autres déchets - Light grey RAL 9022	55784	-	55420	-	54822	-	55586	54802
Verre - Yellow green RAL 6018	55786	-	55423	-	54825	-	55589	54805
Gobelets - White RAL 9016	55788	-	55418	-	54820	-	55584	54800
Cartouches - Brown RAL 8001	55787	-	55417	-	54819	-	55583	54799
Papiers confidentiels - Sky blue RAL 5015	-	54835	-	54837	-	54839	-	-
Emballages - Colza yellow RAL 1021	54845	-	54847	-	54849	-	54851	54853
<b>WHITE front</b>								
Papier - Sky blue RAL 5015	55370	-	55414	-	54816	-	55580	54796
Plastique - Colza yellow RAL 1021	55371	-	55415	-	54817	-	55581	54797
Métal - Traffic red RAL 3020	55372	-	55412	-	54814	-	55578	54794
Autres déchets - Light grey RAL 9022	55373	-	55413	-	54815	-	55579	54795
Verre - Yellow green RAL 6018	55374	-	55416	-	54818	-	55582	54798
Gobelets - White RAL 9016	55376	-	55411	-	54813	-	55577	54793
Cartouches - Brown RAL 8001	55375	-	55410	-	54812	-	55576	54792
Papiers confidentiels - Sky blue RAL 5015	-	54834	-	54836	-	54838	-	-
Emballages - Colza yellow RAL 1021	54844	-	54846	-	54848	-	54850	54852



FOR CONNECTED SOLUTIONS - CONTACT US



# Cubatri

40L - 65L

Inner bucket

Windowless facades

Without castors



65L  
Manganese  
grey front

40L  
White front

Optimised document security. Protection of the private content of confidential documents against unauthorised access

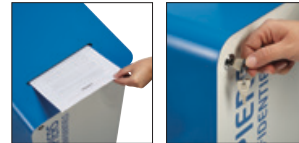

## CUBATRI

### MODULAR WASTE SORTING BIN WITH INNER BUCKET

- Anti-UV powder-coated steel
- Push/pull opening system thanks to its mechanical latch\*\*\*
- 4 adjustable plastic feet for uneven floors
- Waste identification on the door
- Recyclable product
- 40L inner bucket: black recycled polypropylene
- 65L inner bucket: black plastic, roll-out bucket, easy to remove for MSD\* prevention
- **"Confidential papers" version:** Locking system with flat key lock Rectangular slot: 230 x 15 mm with deflector
- **"Biowaste" version** (See p22)

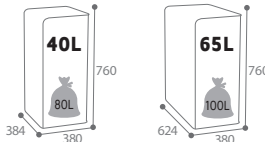

	40L		65L	
	without lock	with lock	without lock	with lock
<b>MANGANESE GREY front</b>				
Papier - Sky blue RAL 5015	55900	-	56120	-
Plastique - Colza yellow RAL 1021	55901	-	56121	-
Métal - Traffic red RAL 3020	55902	-	56122	-
Autres déchets - Light grey RAL 9022	55903	-	56123	-
Verre - Yellow green RAL 6018	55904	-	56124	-
Gobelets - White RAL 9016	55897	-	55963	-
Piles - Violet RAL 4008**	55898	-	-	-
Cartouches - Brown RAL 8001	55899	-	55929	-
Papiers confidentiels - Sky blue RAL 5015	-	54831	-	54833
Emballages - Colza yellow RAL 1021	54841	-	54843	-
<b>WHITE front</b>				
Papier - Sky blue RAL 5015	55850	-	55870	-
Plastique - Colza yellow RAL 1021	55851	-	55871	-
Métal - Traffic red RAL 3020	55852	-	55872	-
Autres déchets - Light grey RAL 9022	55853	-	55873	-
Verre - Yellow green RAL 6018	55854	-	55874	-
Gobelets - White RAL 9016	55855	-	55875	-
Piles - Violet RAL 4008**	55856	-	-	-
Cartouches - Brown RAL 8001	55857	-	55876	-
Papiers confidentiels - Sky blue RAL 5015	-	54830	-	54832
Emballages - Colza yellow RAL 1021	54840	-	54842	-

CREATE YOUR RECYCLING STATION AS PER YOUR NEEDS



## ACCESSORIES

### MODIFICATION

#### METAL INNER BUCKET FOR 40L CUBATRI

- "Anti-UV powder coated steel - 2 integrated handles
  - Elastic strap to hold bag in place"
- Ref. 55887

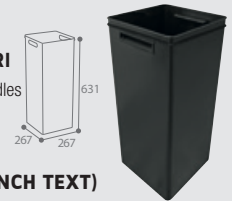

#### COLLEC - SET OF STICKERS (FRENCH TEXT)

- Enables the easy visualisation of waste type
- Withstands indoor and outdoor conditions of use
- Dimensions: 250 x 302 mm (except Ref. 50292)



Type of sorting/Colour	Batch of 10	Batch of 50	Batch of 50 mixed
Papiers confidentiels	50284	-	-
Emballages	50285	50354	-
Piles	50295	-	-
Cartouches	50296	-	-
Gobelets	50338	-	-
Verre	50314	50315	-
Papier	50317	50318	50329
Plastique	50320	50321	
Métal	50323	50324	
Autres déchets	50326	50327	
Jetez vos déchets	50292	-	
Biodéchets	50032	-	-

\* Musculoskeletal disorders \*\* With plastic inner bucket - \*\*\* No mechanical latch on "Confidential papers" lock version

For our Foodwaste CUBATRI go to pg 22





# Hexatri THE 'MUST HAVE'

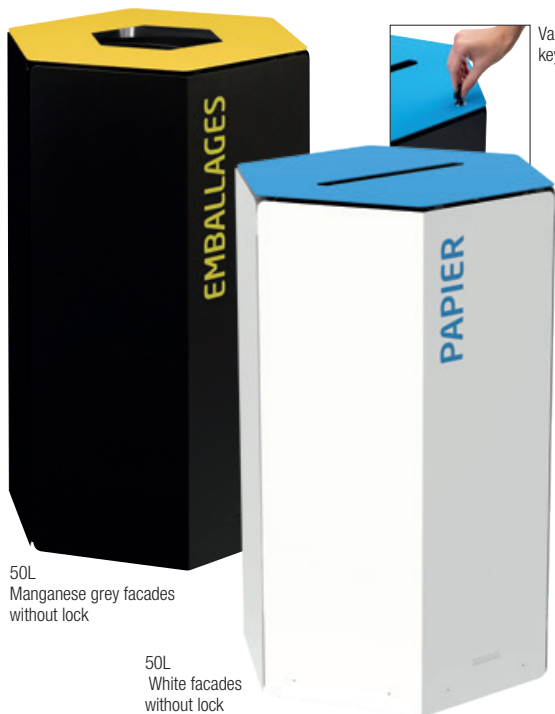

Vandal-proof: key lock

Easy waste removal



## HEXATRI

### WASTE SORTING BIN - 50L

- Anti-UV powder-coated steel.
- Calibrated opening as per waste type
- 3 adjustable plastic feet for uneven floors
- Polypropylene inner bucket with metal handle
- Installation in a covered area
- Silk screen printing on the body
- Supplied with 2 double-sided adhesive strips for fastening to each other

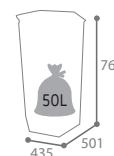

Colour	MANGANESE GREY BODY		WHITE BODY	
	without lock	with lock	without lock	with lock
Papier - Sky blue RAL 5015	59030	59040	59029	59039
Emballages - Colza yellow RAL 1021	59031	59041	59028	59038
Métal - Traffic red RAL 3020	59032	59042	59027	59037
Autres déchets - Light grey RAL 9022	59033	59043	59026	59049
Verre - Yellow green RAL 6018	59034	59044	59025	59055

# Calitri

"SINGLE" OR "MULTI-STREAM"



Removable lid

Easy bag placement and removal



20L



20L, 40L and 60L Island configuration

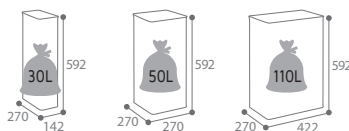

## CALITRI

### WASTE SORTING BIN 20L, 40L AND 60L

- Anti-UV powder-coated steel.
- Calibrated opening as per waste type
- Integrated bag clamp to hold the bag in place
- Installation recommended in a covered area

Colour/Manganese grey body	20L	40L	60L
Sky blue RAL 5015	56165	56170	56175
Colza yellow RAL 1021	56166	56171	56176
Traffic red RAL 3020	56167	56172	56177
Light grey RAL 9022	56168	56173	56178
Yellow green RAL 6018	56169	56174	56179



#### Customisation available subject to quotation

- Wall mounted version
- Calibrated opening as per waste type
- Change of colour
- Addition of Braille
- Adaptation of the signage or language
- Addition of a logo or pictogram



FOR CONNECTED SOLUTIONS - CONTACT US





# TrimouV FUNCTIONAL AND MOBILE



Integrated elastic belt



Easy bucket removal (windowless version)



## TRIMOUV

### MOBILE 2 AND 3 STREAM WASTE SORTING UNIT

- Anti-UV powder-coated steel
- Calibrated openings as per waste type
- Signage on the top and top part of both facades (for non french text request a quote)
- 4 multi-directional castors including 2 with brakes
- 2 lateral handles for easy handling
- Triangular key lock Ø7mm
- Handle on the lid for easy opening
- **Windowless version (with inner buckets):** Removal from above of galvanised steel inner buckets with handles
- **Vigipirate security model:** Easy bag extraction thanks to the elastic strap



2 x 110L Windowless

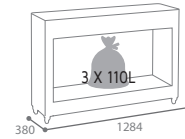
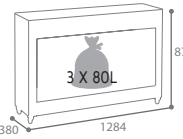
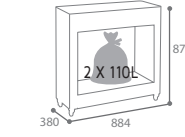
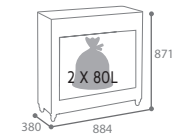

WINDOWLESS

VIGIPIRATE



4 castors including 2 with brakes



Vandal-proof: key locking system (windowless version)



#### Customisation available subject to quotation

- Calibrated opening
- Change of colour
- Addition of Braille
- Adaptation of the signage or language
- Addition of a logo or pictogram

	Windowless		"Vigipirate" security solution	
Manganese grey body	2 x 60L	3 x 60L	2 x 110L	3 x 110L
Emballages / Autres déchets	55450	-	55452	-
Papier / Emballages / Autres déchets	-	55451	-	55453

# Tripoz "LARGE VOLUME" BODY



## TRIPOZ

### WASTE SORTING STATION - 120L

- Anti-UV powder-coated steel
- Vandal-proof: key locking system
- Inner bucket in 100% recyclable virgin HDPE
- Polypropylene pads to avoid contact with the ground
- 2 adjustable plastic feet for uneven floors
- Coloured lid with calibrated openings as per waste type
- Signage on the door
- Installation recommended in a covered area

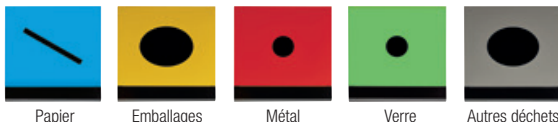

Papier

Emballages

Métal

Verre

Autres déchets

4 x 120L



#### EXAMPLES OF COMPOSITION

WASTE SORTING islands possible side-by-side or back-to-back (connecting accessories supplied)



Colour	Reference
Papier - Sky blue RAL 5015	56078
Emballages - Coiza yellow RAL 1021	56079
Métal - Traffic red RAL 3020	56085
Autres déchets - Light grey RAL 9022	56086
Verre - Yellow green RAL 6018	56099



## Waste sorting Indoor Bin



# Neotri



### NEOTRI

#### WASTE SORTING BIN 15L, 30L AND 50L

- Anti-UV powder-coated steel.
- Integrated bag clamp to hold the bag in place



Integrated bag clamp

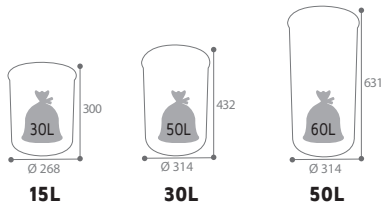

Colour	15L	30L	50L
Manganese grey body			
■ Sky blue RAL 5015	52290	52295	52300
■ Colza yellow RAL 1021	52291	52296	52301
■ Traffic red RAL 3020	52292	52297	52302
■ Light grey RAL 9022	52293	52298	52303
■ Yellow green RAL 6018	52294	52299	52304



50L

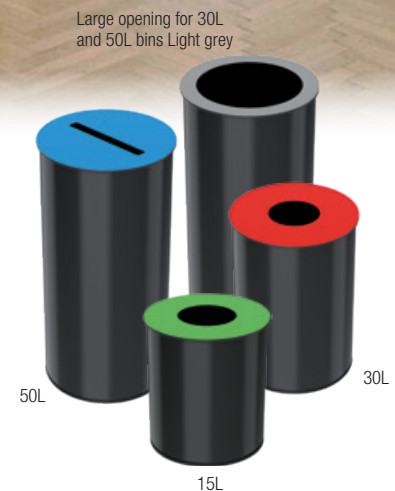

Large opening for 30L and 50L bins Light grey

50L

30L

15L

\*Except 15L

# Pileo FUN

LEAKPROOF CONTAINER  
AVOIDING ACID OR SODIUM  
ION LEAKAGES



2L  
White



7L  
Signal violet

### PILEO

#### TABLE/WORK -TOP BATTERY COLLECTION BOX

- Lid with calibrated opening in powder coated steel
- Transparent, shock-resistant polycarbonate body

Colour	2L	7L
□ Traffic white RAL 9016	59620	59622
■ Signal violet RAL 4008	59621	59623

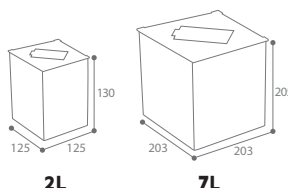

2L

7L

# Tribu

Be ISO  
14001  
compliant



AVAILABLE IN 2 SIZES

## TRIBU

### WASTE SORTING BIN

- Anti-UV powder-coated steel.
- Polypropylene buckets with a grip handle
- Coloured stickers with French text and picto.
- French text can be cut off the top of the sticker to keep picto and colour strip.

- Ref. **55300** - Traffic white RAL 9016 - 2 x 8L
- Ref. **55301** - Traffic white RAL 9016 - 3 x 8L
- Ref. **55302** - Traffic white RAL 9016 - 2 x 15L
- Ref. **55303** - Traffic white RAL 9016 - 3 x 15L



2 x 8L



3 x 15L

FUNCTIONAL  
STYLISH DESIGN

IDEAL FOR OFFICES

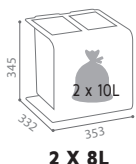

2 X 8L

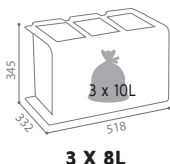

3 X 8L

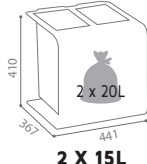

2 X 15L

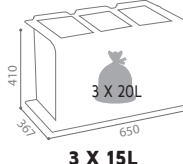

3 X 15L



Waste sorting sticker set included (French text)



# Nomade

INDIVIDUALLY OR MULTI-STREAM



## NOMADE

### MOBILE RECYCLING BIN - 110L

- Anti-UV powder-coated steel
- Easy lid opening: wide pedal
- Easy handling: handle on the front
- Soft close: integrated soft fall hinge
- Removable front: effortless emptying, MSD prevention\*
- 2 wheels to the front
- **HACCP compliant**

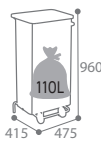

Removable front for easy bag removal and emptying

\* Musculoskeletal disorders

Colour	White body	Manganese grey body
Autres déchets - Light grey RAL 9022	57262	57266
Papier - Sky blue RAL 5015	57263	57267
Emballages - Colza yellow RAL 1021	57265	57269



# Movatri Green



LID WITHOUT APERTURE

LID WITH CALIBRATED APERTURE



85L

110L

65L

REMOVABLE LID

Discover our Waste Sorting sticker set Ref. 50297 (p24)



HIGH MOBILITY



Fold back lid 85L, 110L



## MOVATRI "GREEN"

### MOBILE WASTE SORTING BIN 65L, 85L AND 110L

- Recycled polypropylene
- Smooth castors and carrying handle
- Lid with slotted aperture or no aperture
- Removable lid (65L) or hinged lid (85L and 110L)
- Accessory: set of sorting stickers (Ref: 50297 or 50313 some with French text)

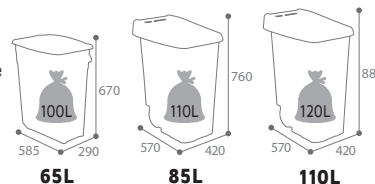

Lid colour	Lid with slot aperture			Lid without aperture		
	65L	85L	110L	65L	85L	110L
■ Black	56180	56185	56190	55500	55505	55510
■ Green	56181	56186	56191	55501	55506	55511
■ Blue	56182	56187	56192	55502	55507	55512
■ Yellow	56183	56188	56193	55503	55508	55513
■ Red	56184	56189	56194	55504	55509	55514

### ACCESSORIES

#### COLLEC SET OF SELF-ADHESIVE STICKERS

- Withstands indoor and outdoor conditions of use
- Can be affixed to all types of surface
- Allows the waste type to be associated with the colour of your choice
- Waste sorting solution

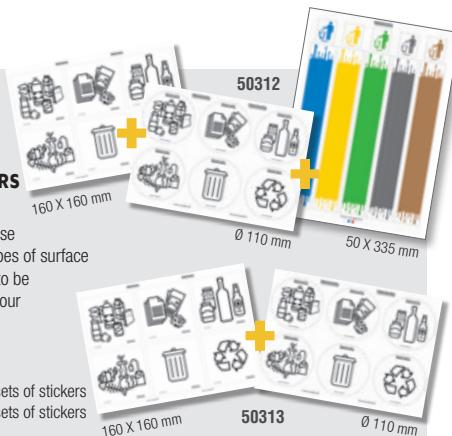

Ref. 50312 - Batch of 3 sets of stickers  
Ref. 50313 - Batch of 2 sets of stickers



### CLAP SWIVEL LID BIN - 50L

- Polypropylene
- Resistant and easy to clean
- Optional wall mounting system Ref. 58875 (p96)

Colour	50L
■ Black body - No lid	91165
■ Black lid	91166
■ Yellow lid	91167
■ Blue lid	91168

Body + Blue lid

Discover our CLAP "GREEN" bins (p96)



### MODULTRI WASTE SORTING BIN 25L (16L + 2 X 4.5L)

- Black main bin, 16 L, in recyclable shockproof polystyrene
- Lids with handles on the 4,5L bins
- Possibility of attaching the 4,5L bins inside or outside the 16L tub
- Facilitates the sorting of 3 types of waste

■ Ref. 59762 - Black body + 2 compartments with blue and yellow lids

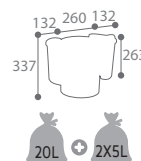

# Citwin Essentiel

ROBUST



twin wall mounted sack holder

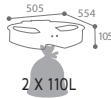

2 X 110L



3-way freestanding sackholder



## CITWIN ESSENTIEL 2 OR 3 WAY SACK HOLDER

- Anti-UV powder-coated steel
- Bag held in place by an elastic strap
- Freestanding or 4 point ground anchoring
- Wall mounted: 4-point anchoring system

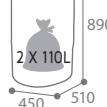
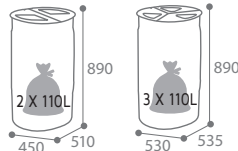

	WHITE body	MANGANESE GREY body	
<b>2-way sack holder</b>	Free-standing 2 x 75L	Free-standing 2 x 75L	Wall-mounted 2 x 110L
■ Ultramarine blue RAL 5002	59312	58713	58622
■ Colza yellow RAL 1021			
■ Cement grey RAL 7033	59313	58708	58641
■ Colza yellow RAL 1021			
<b>3-way sack holder</b>	Free-standing 3 x 45L		
■ Ultramarine blue RAL 5002			
■ Colza yellow RAL 1021	59314	58734	-
■ Cement grey RAL 7033			

Twin freestanding sack holder + kit of 4 castors

**BATCH OF 2 SETS OF SORTING STICKERS SUPPLIED**



Discover our Premium outdoor models (p36)

## ACCESSORIES

### CITWIN PREMIUM

#### INFORMATION PLATE + SET OF STICKERS

- Anti-corrosion treated and anti-UV powder-coated steel
- Comes with 1 set of sorting stickers (French text)
- Accessory for bag holders 2X75L
- Fixing kit supplied

- Ref. 58764 - Manganese grey
- Ref. 57436 - Traffic white RAL 9016



### CITWIN

#### KIT OF 4 CASTORS

- 4 swivel castors Ø50 mm (2 with brake and 2 without brake)
- Facilitates the movement of the CITWIN 2 AND 3 stream sack holders.
- Can be used for CITWIN 2 AND 3 stream

- Ref. 59001 - Kit of 4 castors





# Alitri

ULTRA MODULAR



## CREATE YOUR WASTE SORTING ALITRI STATION

- Anti-corrosion treated and anti-UV powder coated steel

### 1 the tub (choice of 3 sizes)

- Stainless steel rods to protect the surface from tray scratches
- Lock with triangular key
- Mechanical latch with push/pull opening system
- Removable rubber ring on the aperture Ø280/180mm
- 4 height adjustable plastic pads to adapt to uneven floors
- Black plastic inner bucket with wheels, facilitating its extraction and preventing MSD's

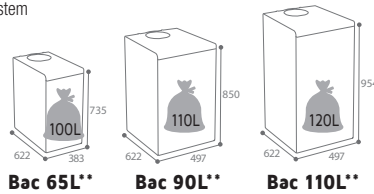

Colour/Manganese grey body	65L Child	90L Teen Adult	110L Teen Adult
Yellow green RAL 6018	55770	55790	53321
Sky blue RAL 5015	55771	55791	53322
Colza yellow RAL 1021	55772	55792	53323
Traffic red RAL 3020	55773	55793	53324
Light grey RAL 9022	55774	55794	53325
Brown RAL 8001	53310	53311	53312
Smooth matt manganese grey (Liquids)	53320	53319	53326

AVAILABLE IN 3 SIZES:  
65L 90L AND 110L

### 2 2 side panels (depending on the chosen size)

#### PACK OF 2 SIDE PANELS

- Closes up both ends of the station
- Dimensions : • 65L : 617 x 17 x 720mm • 90L : 617 x 17 x 838mm • 110L : 617 x 25 x 951mm

Colour	65L	90L	110L
Manganese grey	55765	55764	53330

### 3 Signage plates (7 models to choose from)



- Screen printed signage: French & English text
- Removable plate with pictogram and text for identification of waste type
- Enables the waste type to be associated with the waste colour
- Signage plate can be fixed down with the 2 screw knobs provided

Ref. 55740	- Manganese grey	- Bread
Ref. 55743	- Manganese grey	- Packaging
Ref. 53313	- Manganese grey	- Biowaste
Ref. 53314	- Manganese grey	- Paper
Ref. 53315	- Manganese grey	- Other waste
Ref. 53316	- Manganese grey	- Glass
Ref. 53331	- Manganese grey	- Liquids

Neutral signage plate item 239442SAV + magnetic pouch item 409521SAV - available in after-sales



Example of composition  
53320 + 55765 + 53331

#### LIQUID COLLECTION VERSION

- Stainless steel sink with drain and connecting pipe
- 2 integrated 10L HDPE tubs



## READY TO USE KIT

### MODIFICATION

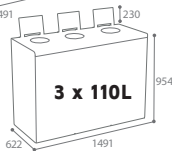
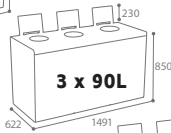
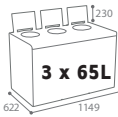

### ALITRI

#### KIT - 3 WAY RECYCLING STATION

##### Composition:

- 3 units (yellow, brown, grey)
- + 2 side panels
- + 3 signage plates (picto + French text: biodéchets, emballages et autres déchets)

Colour	3 x 65L Child	3 x 90L Teen Adult	3 x 110L Teen Adult
Manganese grey body			
Brown RAL 8001			
Light grey RAL 9022	55680	55681	53318
Yellow RAL 1021			



3 x 110L

MODIFICATION

## ACCESSORIES

FACILITATES THE MOVEMENT OF SINGLE OR MULTI-STREAM UNITS

### ALITRI

#### CASTOR KIT

##### Composition:

- 4 swivel castors Ø50mm
- (2 with brake and 2 without brake) for 1 station
- 2 swivel castors Ø50mm
- (without brake) for 1 additional station



■ Ref. 59002 - Kit of 4 castors (for single station)

■ Ref. 59003 - Kit of 2 additional castors (for each subsequent station)



# Cubatri Foodwaste



EASY HANDLING AND EMPTYING OF THE CONTAINER HELPS PREVENT MSD'S\*



**NEW**

**MODIFICATION**

Robust lift up lid



Manganese grey facade 2x20L



White facade RAL 9016 2x10L



2 charcoal filters: limits the spread of odours



Mechanical latch to facilitate opening



## CUBATRI FOODWASTE

### FOODWASTE BIN WITHOUT LOCK

- Anti-UV powder coated steel
- Mechanical push/pull latch on the door
- 4 adjustable plastic feet for uneven floors
- Calibrated opening (170 x 170mm) on the top with lift up lid
- Waste type printed on the door (standard text: French)
- Internal siderails to position the top bucket
- **Unit 2 x 10L** : 2 x 10L brown polypropylene inner bucket with handle, Lid with vents and slot for odour reducing charcoal filter - delivered with 2 charcoal filters (ref. 59238 - pack of 6)
- Maximum load : 10kg/bucket
- **Unit 2 x 20L** : 2 white polypropylene 20L inner bucket with handle and clip on lid
- Slot for 2 odour reducing filters - delivered with 2 charcoal filters (ref. 59238 - pack of 6)
- Maximum load : 30kg/bucket

EASY MAINTENANCE OF INNER BUCKETS



CERIB 130021

Brown body RAL 8001 / Coloured facade	NEW	MODIFICATION
	2 x 10L	2 x 20L
■ Manganese Grey	54255	54720
□ White RAL 9016	54256	54721

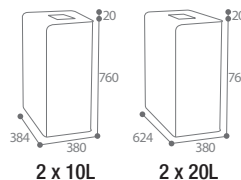

### ACCESSORIES

#### COLLEC

#### "BIODECHETS" STICKERS

- Pack of 10 stickers (French text)
- Dimensions: 250x302mm

Ref. 50032 - Brown

#### PACK OF 6 CHARCOAL FILTERS

- Good absorption and filtration : retains odours
- To be changed every 2 months for optimal odour control

■ Ref. 59238 - Black



X6

\*Musculoskeletal disorders





# Boogy FUNCTIONAL

CHOICE OF 3 TUB COLOURS



Tub + lid same colour

Coloured lid

Coloured lid

**CORROSION RESISTANT STAINLESS STEEL LINKAGE ROD**



Bag held in place by tension: easy removal



White / Green

## BOOGY

### MOBILE PEDAL BIN - 90L

- Polyethylene
- Linkage rod in AISI 304 stainless steel (18/10)
- Wide pedal and built-in handle on front
- Carrying handle
- Optional sticker set (Ref. 50297)
- HACCP compliant

Coloured lid	White Tub	Grey Tub	Coloured Tub
<input type="checkbox"/> White	<input type="checkbox"/> 56700	-	-
<input type="checkbox"/> Yellow	<input type="checkbox"/> 56701	<input type="checkbox"/> 56356	<input type="checkbox"/> 56360
<input type="checkbox"/> Blue	<input type="checkbox"/> 56702	<input type="checkbox"/> 56357	<input type="checkbox"/> 56362
<input type="checkbox"/> Green	<input type="checkbox"/> 56703	<input type="checkbox"/> 56358	<input type="checkbox"/> 56361
<input type="checkbox"/> Red	<input type="checkbox"/> 56705	<input type="checkbox"/> 56359	<input type="checkbox"/> 56363
<input type="checkbox"/> Grey	-	<input type="checkbox"/> 56364	-

# Utilo PRACTICAL AT A VERY ATTRACTIVE PRICE

## UTILIO

### PEDAL BIN 30L, 50L, 80L AND 100L

- Polypropylene
- Wide pedal on the front
- Plastic pedal mechanism
- Resistant and easy to clean
- Optional sticker set (Ref. 50297)
- HACCP compliant



30L

50L

80L

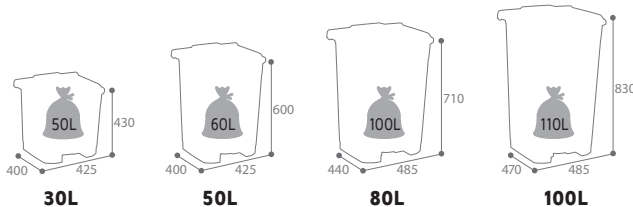

30L

50L

80L

100L

White tub Coloured lid	30L	50L	80L	100L
<input type="checkbox"/> White	54020	54040	54060	54080
<input type="checkbox"/> Blue	54021	54041	54061	54081
<input type="checkbox"/> Green	54022	54042	54062	54082
<input type="checkbox"/> Red	54023	54043	54063	54083
<input type="checkbox"/> Yellow	54024	54044	54064	54084



100L

White / Blue + sticker



Grip handle



Wide pedal

Discover our Waste Sorting sticker set Ref. 50297 (p24)





Waste sorting

Catering

# Mobily

AVAILABLE  
IN 3 SIZES



## MOBILY

### MOBILE PEDAL BIN 60 L, 80L AND 120L

- High-density polyethylene (HDPE)
- Wide pedal on the front
- Smooth wheels
- Carrying handle
- Optional sticker set (Ref. 50297)
- **HACCP compliant**

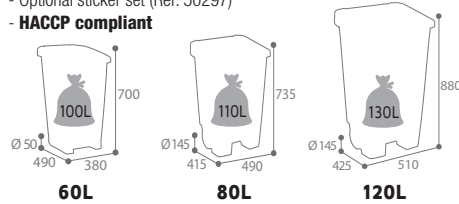

White Tub Coloured lid	60L	80L	120L
White / White	59837	59185	59200
White / Yellow	59877	59188	59203
White / Blue	59876	59187	59202
White / Green	59875	59186	59201
White / Red	59878	59189	59204
White / Brown	50018	-	-



Hinged lid

White/Yellow + sticker

## MOBILY "GREEN"

### MOBILE PEDAL BIN 60L

- **Recycled high-density polyethylene**
- Wide pedal on the front
- Smooth wheels
- Carrying handle
- Optional sticker set (Ref. 50297)
- **HACCP compliant**

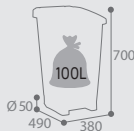

Grey tub Coloured lid	60L
Grey / Grey	59229
Grey / Yellow	59231
Grey / Blue	59230
Grey / Green	59232
Grey / Red	59234
Grey / Brown	50019



## ACCESSORIES



### COLLEC

#### SET OF 7 WASTE SORTING STICKERS

- Withstands indoor and outdoor conditions of use
  - Vinyl adhesive, can be affixed to all types of support
  - Easy for users to identify waste type (some text in French)
  - Dimensions 1 tab: 100 x 250 mm
- Ref. 50297 - Batch of 7 stickers

# Organik "Green"

ODOURLESS COMPOST



## ORGANIK "GREEN"

### KITCHEN COMPOST BIN 10L

- Recycled plastic
- Carry handle and ventilation holes
- Ideal for the temporary storage of peelings and other foodwaste prior to emptying into a garden composter
- Delivered with 1 charcoal filter

Ref. 59237 - Brown



Integrated charcoal filter : limiting the spread of odours



## CONSUMABLES

### BATCH OF 6 CHARCOAL FILTERS

- Good absorption and filtration: retains odours
- To be changed every 2 months for optimal odour control

Ref. 59238 - Black



# Collecroule BEST SELLER



## COLLECROULE

### MOBILE BAG HOLDER WITH PEDAL 50L AND 110L

- Anti-UV powder-coated steel or stainless steel
- Wide pedal
- Bag held by an elastic strap
- HACCP compliant

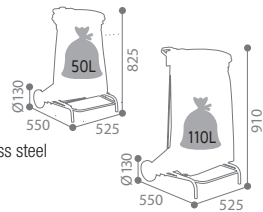

Carrying handle for improved handling



Grey 50L

Colour	50L
■ Grey RAL 9022	57371
Colour	110L
■ Grey RAL 9022	57330
□ Traffic white RAL 9016	57370
■ Stainless steel	56501
■ Grey RAL 9022/Ultramarine RAL 5002	57331
■ Gray RAL 9022/Moss green RAL 6005	57333
■ Grey RAL 9022/Colza yellow RAL 1021	57334
■ Grey RAL 9022/Traffic red RAL 3020	57335



### ACCESSORIES

IDEAL FOR CREATING SORTING STATION

#### CONNECTING PLATE FOR SORTING STATION

- Anti-UV powder-coated steel
- 4 PVC clamps screwed to the plate
- Enables the fixing together of 2 COLLECROULE or TUBAG sack holders

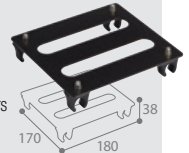

■ Ref. 57223 - Manganese grey

# Pratik HIGH RESISTANCE



### FOOD COLLECTOR 100L

- **White model:** high density polyethylene (for use between -50° to 80/120°C)
- **Coloured models:** polypropylene (for use between -10° à 120/140°C)
- **Suitable for food use**

Colour	Tab	Lid
□ White	56285	56290
■ Yellow	56286	56291
■ Red	56287	56292
■ Blue	56288	56293
■ Green	56289	56294

### ASSEMBLE YOUR PRATIK FOOD BIN

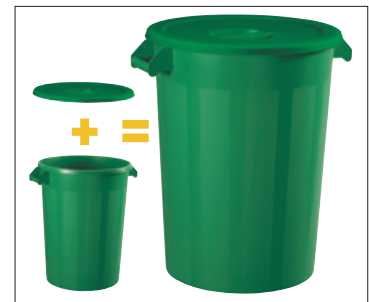

### ACCESSORIES

#### DOLLY WITH CASTORS

- Compatible with the PRATIK 100 L bins
- 5 wheels
- Integrated brake

■ Ref. 57633 - Black

#### Better support of the tub

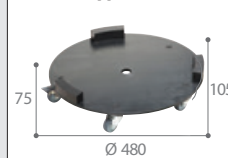

### LEGISLATION



#### FOOD CONTACT

The legislative framework of the suitability for food contact was defined by European Directive 82/711/EEC of 18 October 1982, as well as by Article 3 of European Regulation 1938/2004. It guarantees that the object and materials of which it is composed pose no toxicity risk when in contact with food or drinks. Good hygiene practices require this type of item be inert when in contact with food, to prevent any migration of products and any catalytic effect that may alter the taste or quality of the foodstuff.



FOR CONNECTED SOLUTIONS - CONTACT US



# Trirok

## 3 CONFIGURATIONS :

- 3X BIN - SOLID SIDES
- 1X BIN - FOODWASTE
- 3X BIN - CLEAR/ANTI-TERRORISM



- 3 BILATERAL COMPARTMENTS WITH
- CALIBRATED OPENINGS
  - INTEGRATED GUIDERS
  - WASTE TYPE SIGNAGE (for other colours/text please ask)

HANDLING TOOL FACILITATES PLACEMENT AND HANDLING



## TRIROK

### 3 WAY RECYCLING STATION WITH 3 WHEELIE BINS 120L, 240L, AND 340L

- Anti-UV powder coated steel with anticorrosion primer
- Recyclable
- Monoblock top cover and reinforced tubular structure
- 3 doors on one side with 8mm slam latches
- 6 point ground fixing
- Clear visualisation and easy disposal of waste
- Handling tool advised for unloading and handling (Ref. 51957)
- Delivered with 3 HDPE wheelie bins, facilitating handling and preventing MSD's\*
- Unit 3 x 120L : 120L wheelie bin
- Unit 3 x 240L : 240L wheelie bin
- Unit 3 x 340L : 340L wheelie bin

■ Ref. 51955 - 3 x 120L - Textured anthracite mat RAL 7016

■ Ref. 51953 - 3 x 240L - Textured anthracite mat RAL 7016

■ Ref. 51954 - 3 x 340L - Textured anthracite mat RAL 7016 **NEW**

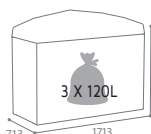

3 X 120L



3 X 240L



3 X 340L

Easy handling of the wheelie bins: prevention of MSD's

\*Musculoskeletal disorders



**NEW**

EASY INTEGRATION INTO HIGH-TRAFFIC AREAS: VISIBLE AND PRACTICAL

Manual hatch



Pedal operated opening



**120L**

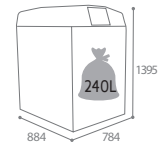

**240L**

**TRIROK**



**FOODWASTE RECYCLING BIN WITH FOOT-PEDAL AND MANUAL HATCH - 1 WHEELIE BIN - 120L AND 240L**

- Anti-UV powder coated steel with anticorrosion primer - Recyclable
- Monoblock top cover
- delivered with 1 wheelie bin 120L or 240L with lid
- 1 door to the front with 8mm slam latch and lock
- 4 point ground fixing
- Waste hatch can be pedal activated (hatch has integrated handle)
- Side vents for aeration and to reduce odours

- Ref. 51948 - 120L - Textured anthracite mat RAL 7016
- Ref. 51949 - 240L - Textured anthracite mat RAL 7016

**NEW**



**TRIROK**

**OUTDOOR RECYCLING BIN WITH 3 SACKHOLDERS 3x110L**

- Anti-UV powder coated steel with anticorrosion primer
- Monoblock top cover and reinforced tubular structure
- Delivered with 3 internal removable sack holders
- 3 doors + 3 rear panels in polycarbonate
- Doors with 8mm slam latch and lock
- 6 point ground fixing
- Handling tool advised for unloading and handling (Ref. 51957)
- 3 compartments : calibrated openings / deflectors / waste type signage (in French)

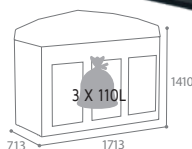

- Ref. 51958 - 3 x 110L - Textured anthracite mat RAL 7016

**ACCESSORIES**

**TRIROK**

**HANDLING TOOL FOR UNLOADING RECYCLING BIN**

- Anti-UV powder coated steel with anticorrosion primer
- Recyclable



- Ref. 51957 - Textured anthracite mat RAL 7016



# Artri

STYLISH AND STURDY



ARTRI recycling station configuration



Version with ashtray



## ARTRI

### FREE-STANDING OR FLOOR ANCHORED BIN - 110L

- Door cannot be unhinged: riveted fixed pin butt hinge
- Locking with 8mm triangular key lock
- Bag held by bag clamp
- Can be fixed to each other (1 point) or 3 point ground fixing
- Ashtray version: cigarette stubb out grid integrated into the top



### ARTRI

- Anti-corrosion treated and anti-UV powder-coated steel
- Door + rear with laser cut design and clear polycarbonate panels
- Screen printing on the door, rear and hood (for text other than French please ask us)
- Pest control plate supplied to be installed at the bottom of the bin

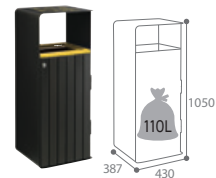

### ARTRI ALU

- Anti-corrosion treated and anti-UV powder-coated steel.
- Door + rear with powder coated aluminium slats
- Screen printing on the hood (for text other than French please ask us)



### ARTRI EXTREME\*\*

- Hot-dip powder-coated galvanised steel.
- Door + rear with powder coated aluminium slats
- Screen printing on the hood (for text other than French please ask us)

Colour / Corps	ARTRI	ARTRI ALU	ARTRI EXTREME
■ Papier - Sky blue RAL 5002	54928	54920	54924
■ Emballages - Colza yellow RAL 1021	54929	54921	54925
■ Autres déchets - Cement grey RAL 9022	54930	54922	54926
■ Autre déchets + ashtray - Cement grey RAL 9022	54931	54923	54927

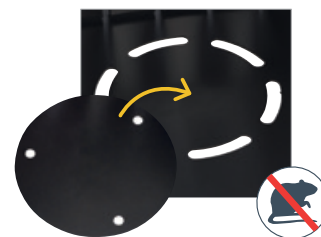

Pest-control bottom plate included to be installed at the bottom of the bin for ARTRI version

\* Subject to compliance with installation and maintenance guidelines. \*\* The product may develop an uneven surface as a result of the treatment.



# Cybel

ROBUSTNESS AND GOOD CORROSION RESISTANCE

## ATTRACTIVE DESIGN

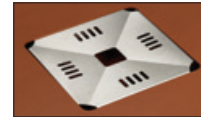

Ashtray 1.5L  
900 butts

Stub out grid integrated into the hood



Corten effect + stickers



Corten effect

Unlocking by simply pressing

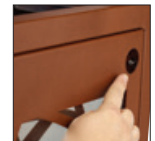

Bags held in place by bag clamps



Anthracite grey



### CYBEL

#### FREE STANDING OR FIXED BIN - 2X60L WITH ASHTRAY 1.5L

- Anti-corrosion treated and anti-UV powder-coated steel.
- 4 laser cut facades with clear polycarbonate liners
- 1 door on the front
- Door cannot be unhinged: riveted fixed pin butt hinge
- Discreet keyless locking by ratchet (access through door hole)
- Cigarette stub-out grid in AISI 304 stainless steel (18/10)
- 3-point ground-anchoring system possible
- Pest-control plate supplied to be installed at the bottom of the bin
- Optional set of sorting stickers to stick on (Ref. 50281)



Pest-control plate

Colour	2 x 60L
■ Anthracite grey RAL 7016	59352
■ Corten effect	59353



### ACCESSORIES

#### COLLEC

##### SET OF STICKERS

- Glossy vinyl adhesive
- Information: RECYCLABLE - NON-RECYCLABLE

Ref. 50281 - Batch of 8 stickers

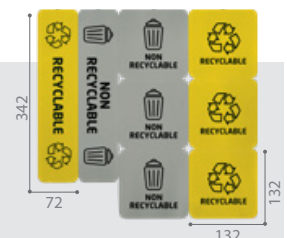

Discover our CYBEL 1-stream bins (p44)



Waste sorting

Outdoor bin



# Arkea



Arkea Métal without Ashtray



**ARKEA**

**GROUND FIXED BIN: METAL OR ETIK 12 X 60 L**

- Anti-corrosion treated and anti-UV powder coated steel
- ETIK version: robust slats made from aseptic packaging, 100% recycled, 100% recyclable (maintenance free)
- 2 plaques fixed to the facades to identify the waste type
- Easy to open by tilting the facade forward
- 4-point floor-anchoring system
- Reduced opening to prevent the introduction of bulky objects
- Discreet keyless ashtray locking system
- Supplied with stickers to be placed on the facades (Recyclable / Non Recyclable)



Bag clamp to facilitate insertion and removal of the bag

Ashtray 3L  
1800 butts

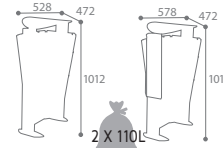

Arkea METAL

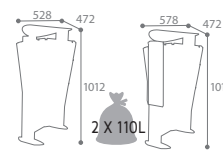

Arkea ETIK



Recycled aseptic packaging

Ground fixed bin	ARKEA MÉTAL		ARKEA ETIK	
Colour Manganese grey structure	2 x 60L	2 x 60L + Ashtray 3L	2 x 60L	2 x 60L + Ashtray 3L
■ Light grey RAL 9022 ■ Colza yellow RAL 1021	56374	56377	59285	59315

Discover our ARKEA wooden bins (p58)



# Kolotri

**KOLOTRI**

**FREE-STANDING OR GROUND-ANCHORED BIN - 80L**

- Aluminium and UV-resistant powder-coated bin for extreme environmental conditions
- Manganese grey body
- Lid with angular deflection of 90° and built-in stop
- Coloured Lid with calibrated aperture adapted to different waste types
- Clear signage for waste type
- Easy bag placement and removal due to stainless steel bag clamps
- 4 polypropylene pads avoiding contact with the ground
- 4-point floor-anchoring system possible

Colour/Manganese grey body	80L
■ Papier - Sky blue RAL 5002	58500
■ Emballages - Colza yellow RAL 1021	58501
■ Autres déchets - Light grey RAL 9022	58504

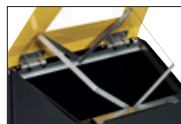

Bag clamps to facilitate bag insertion and removal



**KOLITRI BIN 100% CUSTOMISABLE ON SIMPLE REQUEST**

- Calibrated opening
- Change of colour
- Addition of Braille
- Adaptation of the signage
- Incorporation of foreign languages
- Addition of a logo or pictogram



Island in foreign languages

\* Subject to compliance with installation and maintenance guidelines





# Tulipe

OPTIMISATION OF WASTE SORTING



VERY ROBUST,  
GOOD CORROSION RESISTANCE

**NEW**



2x40L bin with 2 inner buckets + optional pack of 2 stickers (Ref 50034)



## TULIPE

### 2X40L & 2X60L - FREE-STANDING OR FIXED BIN

- Anti-corrosion treated and anti-UV powder coated steel
- Rubber rim on the base + perforated base
- Free-standing or 3 point ground fixing
- **2 x 40L** : 2 x 40L galvanised steel inner buckets with carry handle  
2 covers with locks and 2 calibrated apertures each Ø 170mm  
Optional set of 2 stickers (ref. 50034)
- **2 x 60L** : 2 internal bag clamps. Optional 40L inner buckets (ref 58061)  
Version with signage plate : optional set of 2 stickers (ref. 50033)

**NEW**

Colour	2 x 40L		2 x 60L	
	Litter bin with covers	Litter bin	Litter bin	Litter bin with signage plate
■ Olive green RAL 6003	54560	54520	54524	
■ Moss green RAL 6005	54561	54521	54525	
■ Manganese grey	54562	54522	54526	
■ Textured anthracite mat RAL 7016	54563	54523	54527	



Perforated base for rainwater drainage

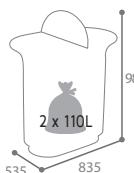
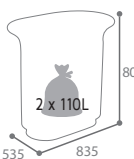
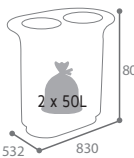

Bag clamp facilitating bag insertion and removal



2x60L bin with bag clamps



2x60L bin with bag clamps + signage + optional pack of 2 stickers (Ref 50033)

### ACCESSORIES

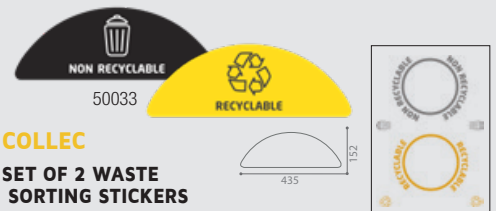

#### COLLEC

#### SET OF 2 WASTE SORTING STICKERS

- Withstands indoor and outdoor conditions of use
- Enables easy identification of waste type

Ref. **50033** - Pack of 2 stickers for 2x60L (with signage plate)  
Ref. **50034** - Pack of 2 stickers for 2x40L (with lids)

**NEW**



# Waste sorting Outdoor bin



## Bag holders COLLECTO - COLLECTMUR - COLLECTRAP

### WALL MOUNTED BAG HOLDER WITH OR WITHOUT LID - 110L

- ESSENTIEL model: anti-UV powder coated steel
- EXTREME model: hot-galvanised, anti-corrosion treated, anti-UV powder-coated\*\* steel
- Bag held in place by an elastic strap
- Wall-mounted system: 1 optional fixing plate to facilitate installation See p35
- Post-mounted: clamp supplied (post optional, see p34)
- COLLECTRAP model: hatch in AISI 304 stainless steel (18/10) and triangular lock key



PRACTICAL, SIMPLE AND DURABLE!

EXTREME VERSION:  
HOT DIPPED GALVANISED



Bag holder	COLLECTO Without lid		COLLECTMUR With lid		COLLECTRAP With hatch
	ESSENTIEL	EXTREME	ESSENTIEL	EXTREME	ESSENTIEL
Colour					
■ Ultramarine RAL 5002	57075	57829	57957	57805	57517
■ Manganese grey	57097	57831	58216	57806	57519
■ Moss green RAL 6005	57115	57830	57953	57804	57518
■ Colza yellow RAL 1021	58207	57828	57952	57803	57514
■ Olive green RAL 6003	58208	57832	58223	57807	57520
■ Hot-dip galvanised	-	57118	-	57798	-
■ Traffic red RAL 3020	57095	57826	58202	57816	57522

Discover all our accessories for bag holders (p34 and 35)



### CONSUMABLES

#### BAGY "GREEN"

##### BIN BAGS - TRANSPARENT

- Low-Density Polyethylene Bags with the French norm (NF) label. With polyethylene tie
- **100% recycled, 100% recyclable** (burning the bags does not cause any harmful or corrosive fumes, only water vapour and carbon dioxide).



Ref.	Size	Corresponding bin size	Dimensions in mm (Length x Width x Height)	Thickness	Quantity of bags/ pack	Pack breakdown
99105	110L	70 to 110 L	360 x 320 x 1100	36 µ	100 bags	10 rolls of 10 bags

\* Subject to compliance with installation and maintenance guidelines. \*\* The product may develop an uneven surface as a result of the treatment.

# Examples of arrangements



## 1-STREAM



## 2-STREAM



## 3-STREAM

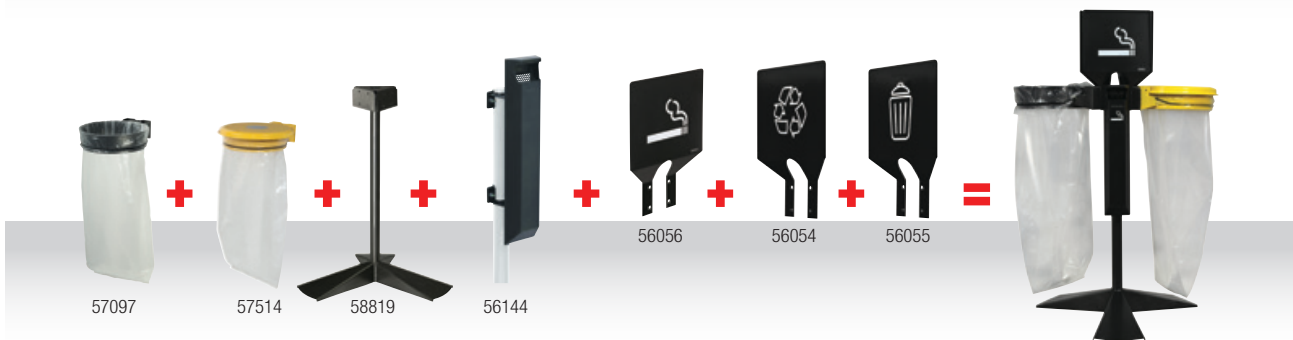
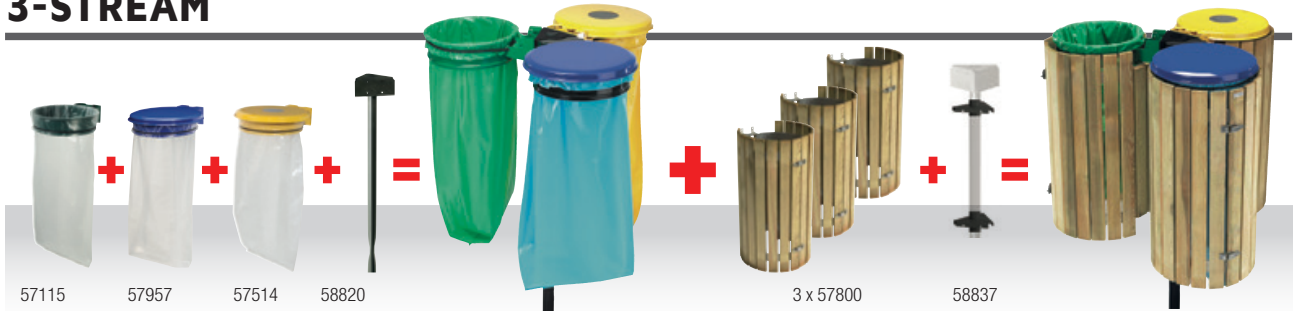



# Collec Posts

## 1 STREAM

- Anti-corrosion primer, anti-UV powder coated steel



**FREE-STANDING OR GROUND-ANCHORED POST ON STAND**

■ Ref. 56831 - Manganese grey

### ACCESSORIES

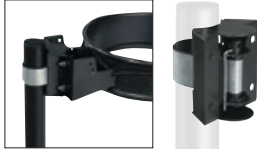

#### UNIVERSAL FIXING KIT

- Enables the mounting of Ecolecto, Collecumur, or Collectrap onto a round post with a 800mm galvanised steel strip (min post Ø 50mm, max post Ø 250mm)
- Easy mounting
- Can be adapted to existing posts
- Post not supplied

■ Ref. 58011 - Manganese grey

## 1 OR 2-STREAM

- Anti-corrosion treated and anti-UV powder coating or hot-dip galvanised steel



**POST CENTRED ON FREE-STANDING BASE**

■ Ref. 58028  
Manganese grey



**GROUND-ANCHORED ROUND POST**

■ Ref. 57841  
Manganese grey  
■ Ref. 59465  
Hot-dip galvanised steel\*



**POST-CENTRED ON A GROUND-ANCHORED PLATE**

■ Ref. 56873  
Manganese grey

## 3-STREAM

- Anti-corrosion primer, anti-UV powder coated steel

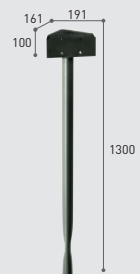

**3-STREAM GROUND-ANCHORED SUPPORT POST**

■ Ref. 58820  
Manganese grey

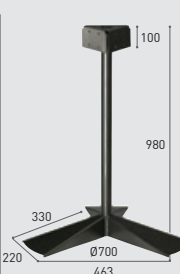

**FREE-STANDING 3-STREAM SUPPORT POST**

■ Ref. 58819  
Manganese grey

### ACCESSORIES

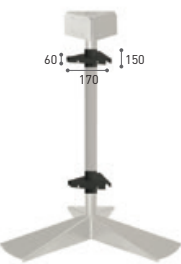

**KIT OF 2 CLAMPS FOR 3-BIN POSTS**

■ Ref. 58837  
Manganese grey

## 4-STREAM

- Anti-corrosion primer, anti-UV powder-coated steel  
- Place for 4 bag holders

■ Ref. 57538 - Manganese grey

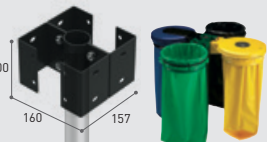

# Collec Surrounds

Compliance with legislation on accessibility relating to "persons of reduced mobility" (See p 109)

## COLLEC WIRE SURROUND

- Anti-corrosion primer, anti-UV powder-coated steel
- Adapts to the Collecumur, Ecolecto and Collectrap (can be retro-fitted)

■ Ref. 57801 - Metal grey RAL 9006



Bag removable via the larger gap to one side



## COLLEC GRID SURROUND

- Anti-corrosion primer, anti-UV powder-coated steel or hot-dip galvanised steel
- Adapts to the Collecumur, Ecolecto and Collectrap
- Wall-mounted system: 2 optional plates to facilitate installation (see p31)
- Post-mounted system: fixing clamps supplied

■ Ref. 57852 - Manganese grey  
■ Ref. 57985 - Moss green RAL 6005  
■ Ref. 57970 - Hot-dip galvanised steel\*

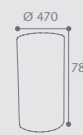

**Practical:**  
emptied from the front



HOT-DIP GALVANISED STEEL VERSION

## COLLEC WOOD AND ETIK SURROUND

- WOODEN slats: "autoclave" treated, certified "Class 4"
- ETIK slats: made from recycled food cartons
- Structure and fasteners in AISI 304 stainless steel (18/10)
- Wall-mounted system: 2 optional plates to facilitate installation (see p.35)
- Post-mounted system: fixing clamps supplied

Ref. 57800 - Softwood  
Ref. 57792 - Grey recycled slats  
Ref. 54140 - Brown recycled slats **NEW**



**Practical:**  
emptied from the front

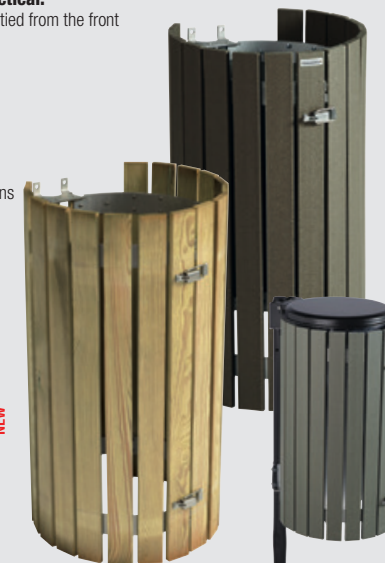

\* Subject to compliance with installation and maintenance guidelines.

# Collec Accessories



The COLLEC and DETEKT accessories make it easier to identify the type of waste to collect and meet the legislation in force.



## COLLEC

### WASTE SORTING INFORMATION PLATE

- Anti-corrosion treated and anti-UV powder coated steel
- Screen-printed information plate
- Facilitates the identification of the waste type

Colour	Wall mounted	For post-mounting
■ Ultramarine RAL 5002 - Papier / Paper	56016	56028
■ Moss green RAL 6005 - Verre / Glass	56018	56029
■ Colza yellow RAL 1021 - Emballages / Packaging	56017	56027
■ Manganese Grey - Autres déchets / Other waste	56019	56026
■ Manganese grey - Recyclable	56051	56054
■ Manganese grey - Non-recyclable	56052	56055

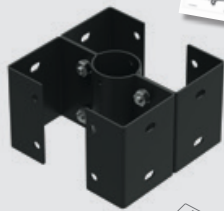

## COLLEC

### MOUNTING KIT BRACKET 4-STREAM

- Anti-corrosion treated and anti-UV powder coated steel
- Place for 4 bag holders

■ Ref. 57538 - Manganese grey

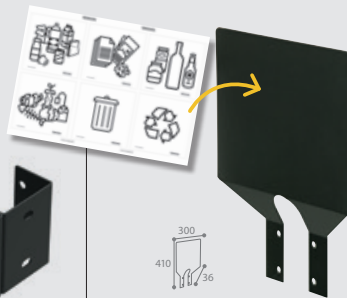

## COLLEC

### POST-MOUNTED NEUTRAL INFORMATION PLATE

- Anti-corrosion treated and anti-UV powder coated steel
- Accessory for the Ecollecto, Collecmur, Collectrap and Tubo bag holders
- Set of self-adhesive sorting stickers supplied

■ Ref. 58486 - Manganese grey

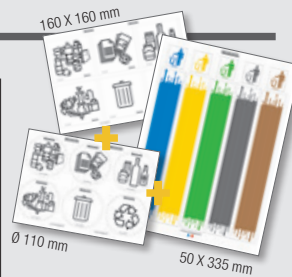

## COLLEC

### BATCH OF 3 SETS OF SELECTIVE SORTING STICKERS

- Withstands indoor and outdoor conditions of use
- Can be affixed to all types of support
- Waste sorting solution: allows the waste type to be associated with the colour of your choice.

Ref. 50312 - Batch of 3 sets of stickers  
Ref. 50313 - Batch of 2 sets of stickers



## COLLEC

### "TOTEM" EXTENSION POST + SIGNAGE

- Anti-corrosion treated and anti-UV powder-coated steel
- Screen printed information plate both sides
- Accessory for the Ø50 mm posts (1-2 stream)

■ Ref. 56785 - Manganese grey

Discover our bag holders (p32)



## COLLEC

### CIGARETTE STUB-OUT GRID

- AISI 304 stainless steel (18/10)
- Post mounting possible

■ Ref. 57168 - Stainless steel

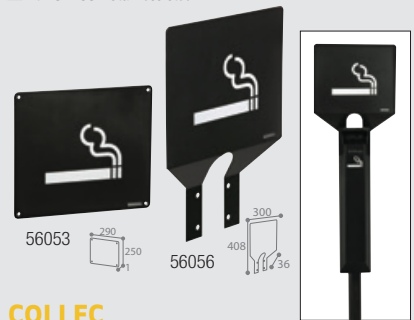

## COLLEC

### WASTE SORTING INFORMATION PLATE - CIGARETTE STUBS

- Standard version: anti-corrosion treated and anti-UV powder coated steel
- Extreme version: stainless steel AISI304 (18/10) treated against corrosion and anti-UV powder coated

■ Ref. 56053 - Wall version - Manganese grey  
■ Ref. 56056 - Post version - Manganese grey  
■ Ref. 55000 - EXTREME wall-mounted version - Manganese grey  
■ Ref. 55012 - EXTREME post-mounted version - Manganese grey

## ENABLES EASIER WALL-MOUNTING OF THE BAG HOLDERS



## COLLEC

### WALL MOUNTING PLATE

- Anti-corrosion treated and anti-UV powder-coated steel
- Accessory for bag holders: Ecollecto, Collecmur, Collectrap, Tubo, Collecgrille, Collecbois and Detekt

■ Ref. 57024 - Manganese grey  
■ Ref. 57025 - Colza yellow RAL 1021  
■ Ref. 57026 - Moss green RAL 6005  
■ Ref. 57027 - Ultramarine RAL 5002  
■ Ref. 57028 - Olive green RAL 6003  
■ Ref. 57029 - Hot-dip galvanised steel\*

## DETEKT

### SACK HOLDER DETECTOR FOR PRM'S

- ESSENTIEL models: Anti-UV powder coated steel
- Wall or post mounting (post mounting bracket supplied)

Color	Kit
■ Colza yellow	58306
■ Ultramarine	58307
■ Moss green	58308
■ Manganese grey	58309
■ Olive green	58311
■ Galvanised	58318



COMPLIANCE WITH THE LEGISLATION ON ACCESSIBILITY RELATING TO "PERSONS WITH REDUCED MOBILITY" (SEE P 109)

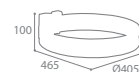

\* Subject to compliance with installation and maintenance guidelines.



Waste sorting

Outdoor bin



# Citwin

WASTE SORTING IN IT SIMPLIST FORM



2 free-standing bins 58799 + information plate 58764



## CITWIN PREMIUM

### BAG HOLDER FREE-STANDING OR WALL-MOUNTED - 2 OR 3 STREAMS

- Anti-corrosion treated and anti-UV powder coated steel
- Bag held by an elastic strap
- Installation recommended in a covered area
- Model with removable 3 L ashtray
- Free-standing: 4-point floor-anchoring system
- Wall mounted: 4-point anchoring system

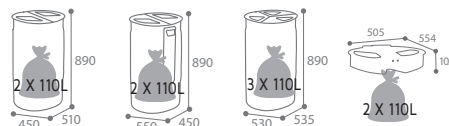

2-way sack holder + 3L ashtray

	MANGANESE GREY body		
	Free-standing 2x75L	Free-standing 2x75L + ashtray 3L	Wall-mounted 2x110L
<b>2 BIN holder</b>			
■ Ultramarine blue RAL 5002	58799	58559	58634
■ Colza yellow RAL 1021			
■ Cement grey RAL 7033	58797	58558	58636
■ Colza yellow RAL 1021			
<b>Support 3 FLUX</b>	Free-standing 3x45L		
■ Ultramarine blue RAL 5002	58826		
■ Colza yellow RAL 1021			
■ Cement grey RAL 7033			

BATCH OF 2 SETS OF RECYCLING STICKERS SUPPLIED



Discover our Essential indoor models White and manganese grey (p19)



## ACCESSORIES

### CITWIN

#### KIT OF 4 CASTORS

##### Composition:

- 4 swivel castors Ø50 mm (2 with brake and 2 without brake)
- Facilitates the positioning of the CITWIN 2 and 3 stream free-standing bin
- Can be used for CITWIN 2 AND 3 stream

■ Ref. 59001 - Kit of 4 castors



### CITWIN PREMIUM

#### INFORMATION PLATE + SET OF STICKERS

- Anti-corrosion treated and anti-UV powder coated steel
- Comes with 1 set of sorting stickers
- Accessory for the CITWIN 2x75L sack holder
- Anchoring kit supplied

■ Ref. 58764 - Manganese grey  
□ Ref. 57436 - Traffic white RAL 9016





# Urban Furniture



# Ballade WOOD / Vibrato EXTREME

GUARANTEED QUALITY WOOD FROM SUSTAINABLY MANAGED FORESTS



Bench  
Anthracite grey

Bench seat  
Manganese grey



## BALLADE WOOD

### GROUND FIXED BENCH AND BENCH SEAT

- 3 or 5 varnished FSC standard wooden slats
- Anticorrosion treated and anti-UV powder coated sheet steel base
- 1 Anti-UV powder coated reinforcement piece
- 4 point ground fixing (optional fixings Ref 51972)
- Easy and quick to install (delivered non assembled)

- Ref. 51965 - Ground fixed bench - Textured Anthracite mat RAL 7016
- Ref. 51966 - Ground fixed bench - Manganese grey
- Ref. 51975 - Ground fixed bench seat - Textured Anthracite mat RAL 7016
- Ref. 51976 - Ground fixed bench seat - Manganese grey

### ACCESSORIES

#### BALLADE / SYMPHONIE / MAESTRO ANCHORING KIT

- Kit contents: 4 mechanical plugs Ø8x100 Stainless steel A4
- + 4 stainless steel Ø8 nuts A4 + 4 stainless steel medium flat washers A4

Ref. 51972 - Anchoring kit

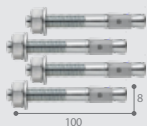

**Ideal in combination with ZENO WOOD bins (p57)**



**NEW**



## VIBRATO EXTREME FREESTANDING PLANTER - 75L

- 4 Light oak effect HPL compact slats
- 4 Corner posts in anti-UV powder coated galvanised steel - Ø 76mm with domed top
- Frame and cross sections in anti-UV powder coated galvanised steel
- 4 height adjustable feet
- Black polyethylene inner liner with overflow valve and water storage
- Delivered assembled

■ Ref. 51988 - Textured Anthracite mat RAL 7016 / Light oak

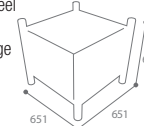

\* High pressure laminate with light oak effect



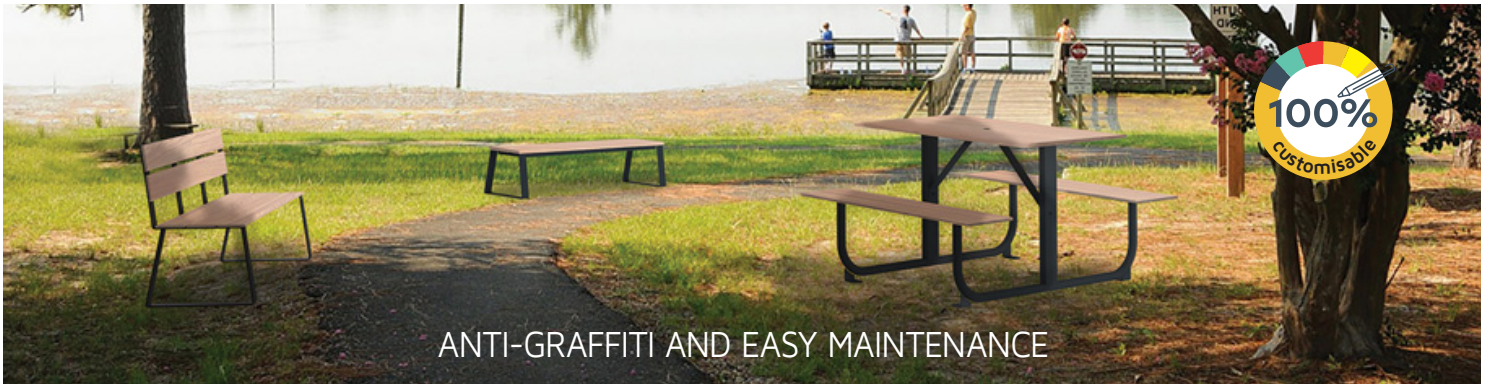

ANTI-GRAFFITI AND EASY MAINTENANCE

# Ballade/Symphonie/Maestro EXTREME



## BALLADE EXTREME

### GROUND FIXED BENCH AND BENCH SEAT

- HPL compact slats\*\* light oak effect
- Anticorrosion treated and anti-UV powder coated galvanised flat steel base
- 2 Anti-UV powder coated galvanised reinforcement pieces (backrest)
- 4 point ground fixing (optional fixings Ref 51972)
- Easy and quick to install (delivered non assembled)

- Ref. **51970** - Ground fixed bench - Textured Anthracite mat RAL 7016
- Ref. **51971** - Ground fixed bench - Manganese grey
- Ref. **51980** - Ground fixed bench seat - Textured Anthracite mat RAL 7016
- Ref. **51981** - Ground fixed bench seat - Manganese grey



Bench  
Anthracite grey

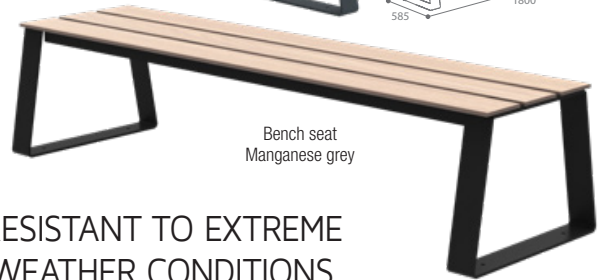

Bench seat  
Manganese grey

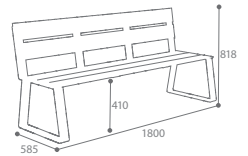

RESISTANT TO EXTREME WEATHER CONDITIONS

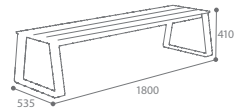

Anthracite mat

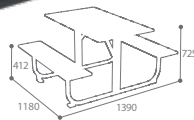

## SYMPHONIE EXTREME

### GROUND FIXED TABLE

- Table top and seats made of compact HPL slats\*\* light oak effect
- Galvanised steel + anti-UV powder coated: Bases 80x40mm on the table - Tube Ø42mm under seats
- 4 point ground fixing (optional fixings Ref 51972)
- Easy and quick to install (delivered non assembled)

- Ref. **51985** - Ground fixed table - Textured Anthracite mat RAL 7016

\*Subject to compliance with installation and maintenance guidelines - \*\*High-pressure laminates in light oak effect



## MAESTRO EXTREME

### WHEELIE BIN CONCEALER - GROUND FIXED

- Compact HPL slats\*\* light oak effect
- Galvanised steel + anti-UV powder coated galvanised steel: Posts 80x40mm - square cross sections 40x40mm
- 2 ground fixing points/post (optional fixings Ref 51972)
- Easy and quick to install (delivered non assembled)

- Ref. **51996** - 2 Screens - Textured Anthracite mat RAL 7016
- Ref. **51997** - 3 Screens - Textured Anthracite mat RAL 7016

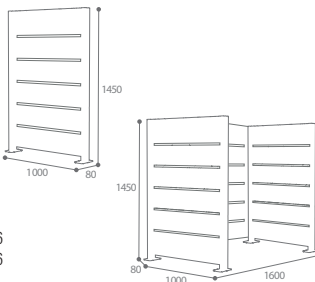

### COMPACT LAMINATE (HPL) LIGHT OAK

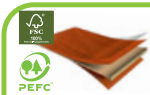

High Pressure Compact Laminate (HPL) consists of layers of kraft paper (approx. 70%) saturated with thermosetting resin (approx. 30%) and bonded together by the action of heat and pressure. CE EN "438" (see P109)

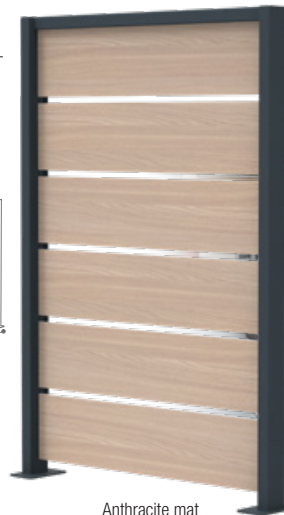

Anthracite mat

CONCEALMENT OF WHEELIE BINS IN URBAN LANDSCAPES



3 Screens



# — Ballade / Maestro / Vibrato METAL

SOLID AND GOOD RESISTANCE TO WEATHER

**NEW**



## VIBRATO METAL FREESTANDING PLANTER - 75L

- 4 Anti-UV powder coated anticorrosion treated steel panels
- 4 Corner posts in anti-UV powder coated anticorrosion treated steel - Ø 76mm with domed top
- Frame and cross sections in anti-UV powder coated anticorrosion treated steel
- 4 height adjustable feet
- Black polyethylene inner liner with overflow valve and water storage
- Delivered assembled

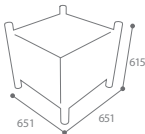

■ Ref. 51987 - Textured Anthracite mat RAL 7016

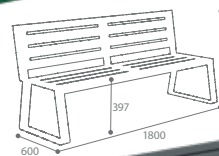

Bench  
Moss green

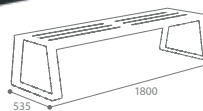
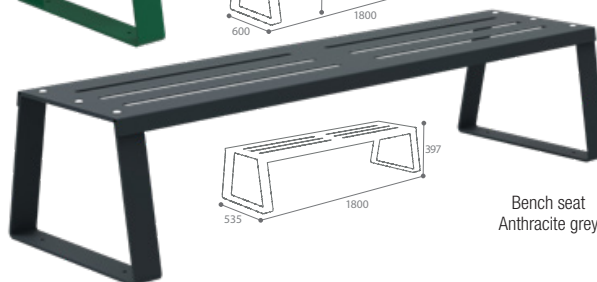

Bench seat  
Anthracite grey

## BALLADE METAL

### GROUND FIXED BENCH AND BENCH SEAT

- Anticorrosion treated and anti-UV powder coated steel (seat and backrest)
- Anticorrosion anti-UV powdered coated flat steel base
- 4 point ground fixing (optional fixings Ref 51972)
- Strip on the front of the seat
- Easy and quick to install (delivered non assembled)

- Ref. 51967 - Ground fixed bench - Textured Anthracite mat RAL 7016
- Ref. 51968 - Ground fixed bench - Manganese grey
- Ref. 51969 - Ground fixed bench - Moss green RAL 6005
- Ref. 51977 - Ground fixed bench seat - Textured Anthracite mat RAL 7016
- Ref. 51978 - Ground fixed bench seat - Manganese grey
- Ref. 51979 - Ground fixed bench seat - Moss green RAL 6005



2 modules



## MAESTRO METAL WHEELIE BIN CONCEALER - GROUND FIXED

- Anticorrosion treated and anti-UV powder coated openwork panels, 80x40mm posts and 40x40 square cross sections
- 2 ground fixing points/post (optional fixings Ref 51972)
- Easy and quick to install (delivered non assembled)



- Ref. 51990 - 2 screens - Textured Anthracite mat RAL 7016
- Ref. 51991 - 3 screens - Textured Anthracite mat RAL 7016



3 modules

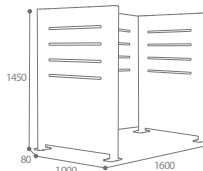

CONCEALMENT OF WHEELIE  
BINS IN URBAN LANDSCAPES



DELIMITATION OF  
PEDESTRIAN SPACES  
AND TRAFFIC LANES

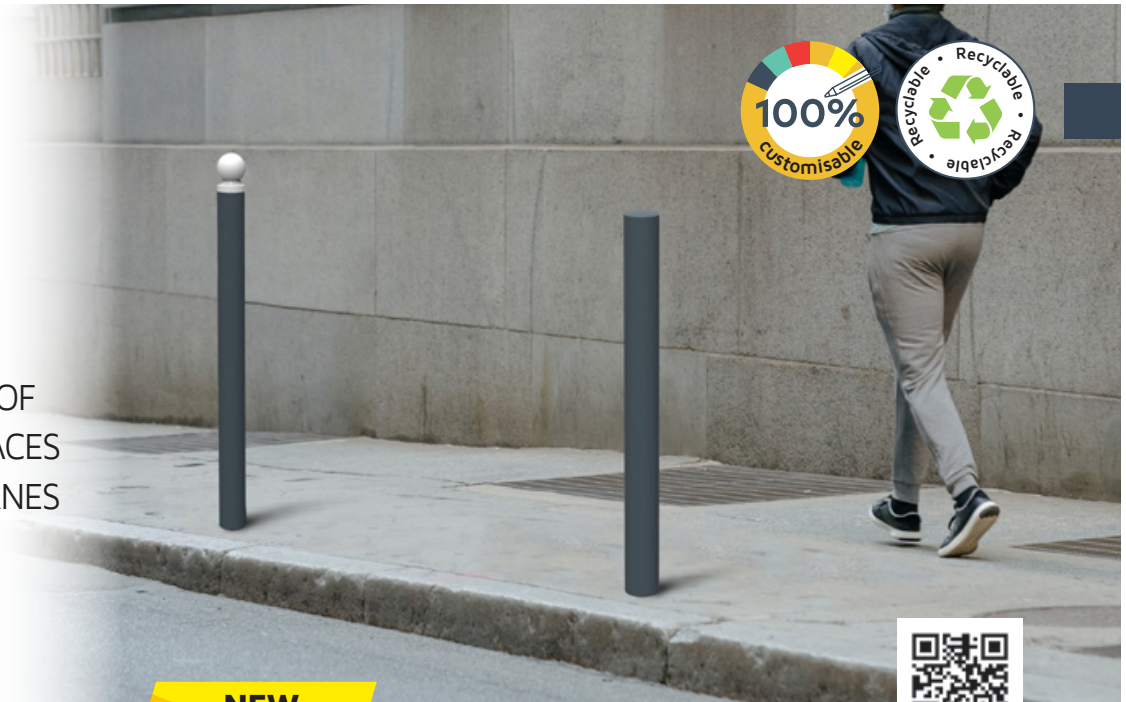

**NEW**

# Opus/Tenor/Alto

**MAKE THE RIGHT "BOLLARD" CHOICE**

3 diameters	3 shapes	1 variant
• Ø 76mm	• OPUS Ball top	• High viz
• Ø 90mm	• TENOR Domed top	• High viz
• Ø 102mm	• ALTO Ornamental top	• High viz



## OPUS/TENOR/ALTO

### GROUND FIXED BOLLARD

- Anticorrosion treated anti-UV powder coated steel
- Tube Ø76, Ø90 or Ø102mm
- To be concreted in with Ø12mm hole (rebar not supplied - optional Ref 409525SAV)

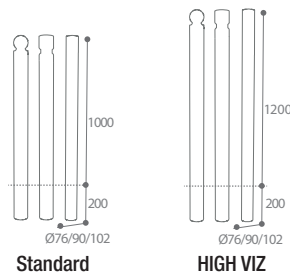

■ Anthracite mat RAL 7016	Ø 76mm		Ø 90mm		Ø 102mm	
	Standard bollard	HIGH VIZ bollard	Standard bollard	HIGH VIZ bollard	Standard bollard	HIGH VIZ bollard
OPUS (Ball top)	51905	51910	51906	51911	51116	51118
TENOR (Domed top)	51907	51912	51908	51913	51117	51119
ALTO (Ornamental top)	51110	51113	51111	51114	51112	51115



**Colours, dimensions and method of attachment on request**  
(on floor mounting plate, removable with simple or lockable sleeves)





Urban Furniture Kerbside



# Cyclo



SECURING BICYCLE PARKING



## OPUS/TENOR

### CONCRETE IN GUARDRAIL WITH SIMPLE CROSS

- Upright tube Ø76mm
- Diagonal tube 30x20x1.5mm; central circle Ø89mm
- Horizontal square tube 30x30x2mm
- To be concreted in with Ø12mm hole (rebar not supplied - optional Ref 409524SAV)

- Ref. 51915 - Ball top - Textured Anthracite mat RAL 7016
- Ref. 51916 - Domed top - Textured Anthracite mat RAL 7016



Ball top version

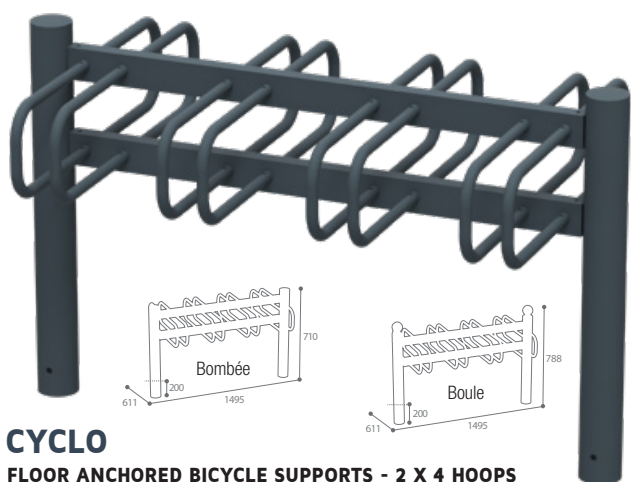

## CYCLO

### FLOOR ANCHORED BICYCLE SUPPORTS - 2 X 4 HOOPS

- Hoops with Ø21 mm tube
- Dome head: 2 mm thick steel dome welded to the tube
- Ball head: steel 1.5 mm thick welded to the tube
- Steel posts 76 mm, thickness 3 mm
- To be concreted in with Ø12mm hole (rebar not supplied - optional Ref 409524SAV)

- Ref. 51962 - Domed top - Textured Anthracite mat RAL 7016
- Ref. 51964 - Ball top - Textured Anthracite mat RAL 7016



Ball top version



For our MOBISAC street cleaning barrows go to P 60



## CYCLO

### CONCRETE IN A-FRAMED BICYCLE RACK

- Anticorrosion treated and anti-UV powder coated steel
- Laser cut bicycle pictogram
- To be concreted in with Ø16mm hole (rebar not supplied - optional Ref 409524SAV)

- Ref. 51960 - Anthracite grey RAL 7016

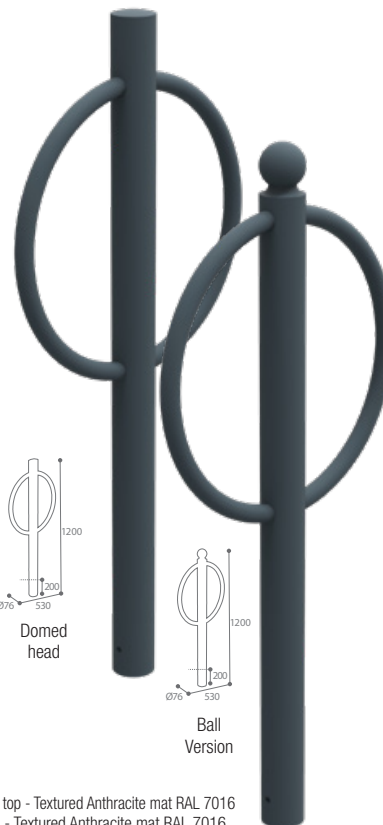

## CYCLO

### CONCRETE IN BICYCLE RACK - SINGLE HOOP

- Steel post Ø76mm
- Ball top: steel welded to the tube
- Domed top: steel dome welded to the tube
- Hoop (for securing bicycles): Ø32mm tube
- To be concreted in with Ø12mm hole (rebar not supplied - optional Ref 409525SAV)

- Ref. 51961 - CYCLO TENOR - Domed top - Textured Anthracite mat RAL 7016
- Ref. 51963 - CYCLO OPUS - Ball top - Textured Anthracite mat RAL 7016



HIGH RESISTANCE,  
ANTI-VANDALISM  
AND SELF-  
STABILISING

**NEW**

# Olympe



## OLYMPE

**FREE-STANDING/FIXED CONCRETE BIN - 80L**

- Concrete bin with exposed aggregate finish
- Anticorrosion treated anti-UV powder coated steel bag clamp

■ Ref. 53335 - Exposed aggregate

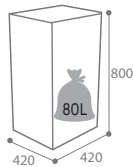

Discover our OLYMPE  
ashtray (P 67)

LARGE CAPACITY

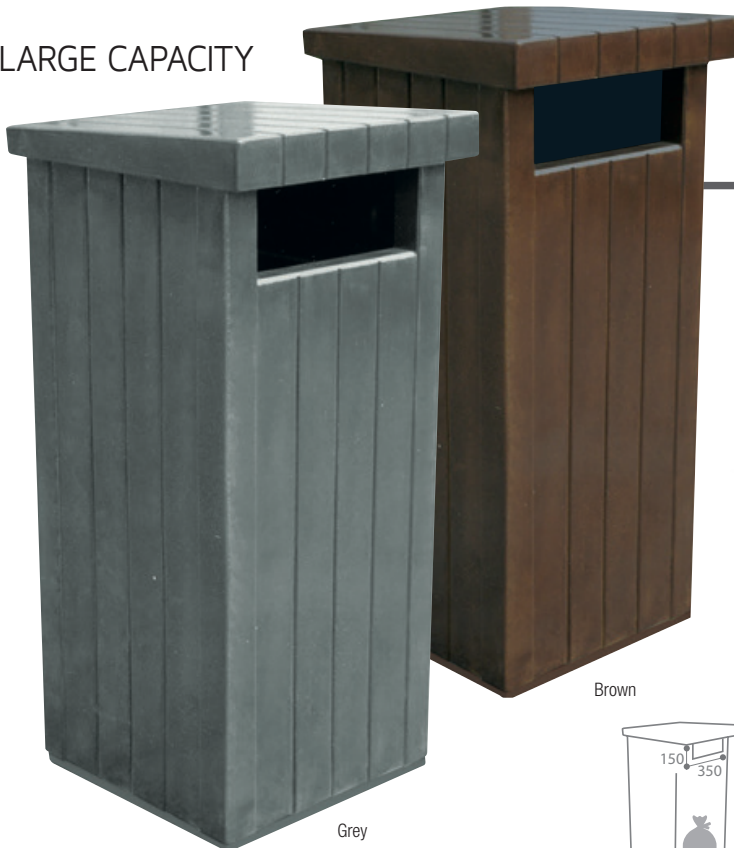

# Zeus

MAINTENANCE FREE



**NEW**



## ZEUS

**FREE-STANDING/FIXED - 130L**

- Polyurethane painted concrete
- Calibrated opening
- Anticorrosion treated + anti-UV powder coated steel rear door with key lock
- Anticorrosion treated + anti-UV powder coated steel sack holder
- 4 point ground fixing, or glued (fixings/concrete glue not supplied)

■ Ref. 53336 - Brown RAL 8011

■ Ref. 53337 - Grey RAL 7016

Brown

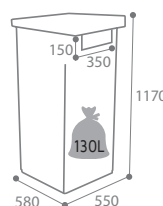

**FOR EXTREME VERSIONS PLEASE CONTACT US**



# Cybel

HIGH RESISTANCE  
VANDAL-PROOF

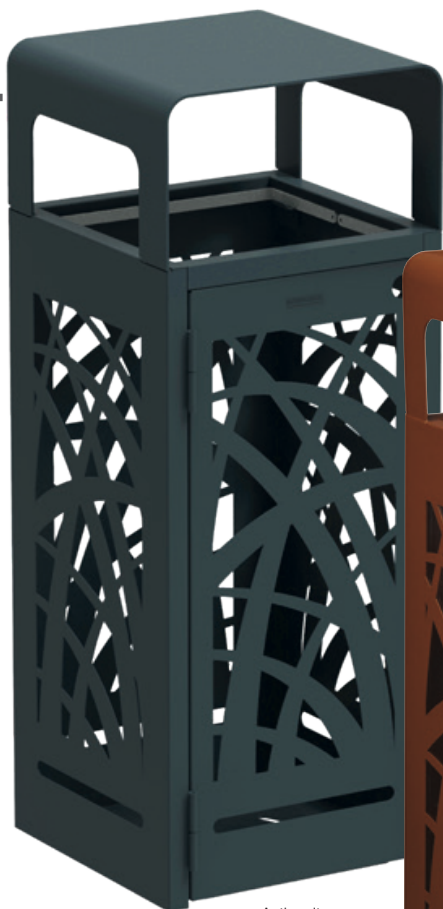

Anthracite grey  
without ashtray



Corten effect  
against pests  
with ashtray

Ashtray 1.5L

900 butts

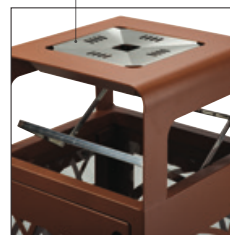

Bag held by Bag clamps



Ratchet unlocking not visible



## CYBEL

FREE-STANDING OR FLOOR ANCHORED BIN - 110 L

- Anti-corrosion treated and anti-UV powder-coated steel.
- **Structure: single steel cutout + door in the facade**
- Riveted fixed pin butt hinges: door cannot come off
- Bag clamps to facilitate bag removal
- **Keyless bin locking with ratchet**  
(access through the door hole)
- 3-point floor-anchoring system or free standing
- **Model with ashtray:** cigarette stub-out grid made of AISI 304 brushed stainless steel (18/10)
- **Pest-control version:** 4 transparent polycarbonate panels, impact resistant and avoids tampering with the bin bag
- Pest-control plate supplied to be installed at the bottom of the bin

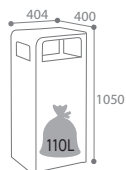

Colour	Standard		Pest-control	
	Without ashtray	With ashtray	Without ashtray	With ashtray
■ Anthracite grey RAL 7016	59300	59305	59320	59330
■ Corten effect	59299	59310	59325	59335



ENTRUST US WITH  
YOUR TAILOR-MADE  
PROJECTS  
(SEE P8)



Discover the CYBEL 2-stream bins,  
Corten and Anthracite effect (p29)

Urban bin



# Bella

MODERN DESIGN



Ashtray 3L  
1800 butts

## BELLA

FREE-STANDING OR FLOOR ANCHORED BIN - 110 L

- Anti-corrosion treated and anti-UV powder-coated steel
- One-piece structure + front door
- Riveted fixed pin butt hinges: door cannot come off
- Bag clamps to facilitate bag removal
- **Keyless bin locking with ratchet** (access through the door hole)
- 3-point floor-anchoring system or free standing
- **Pest-control version:** 4 transparent polycarbonate panels, impact resistant and avoids tampering with the bin bag, + pest control plate supplied to be installed in the bottom of the bin

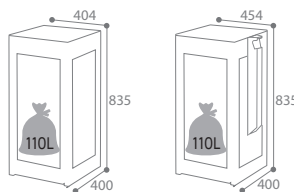

DOOR CANNOT BE UNHINGED: VANDAL-PROOF



Standard openwork bottom

Colour / Ashtray Anthracite mat RAL 7016	Standard		Pest-control	
	Without ashtray	With ashtray	Without ashtray	With ashtray
■ Anthracite grey RAL 7016	59376	59374	59372	59370
■ Corten effect	59377	59375	59373	59371



ENTRUST US WITH YOUR TAILOR-MADE PROJECTS (SEE P18)



Pest-control bottom plate included



Urban Furniture Urban bin

# Arkea



Wall-mounted 40L  
Cement grey

Ground fixed 60L  
Vigipirate security solution  
Cement grey

Ground fixed 60L  
With ashtray  
Metal grey

Ground fixed 100L  
With ashtray  
Manganese grey

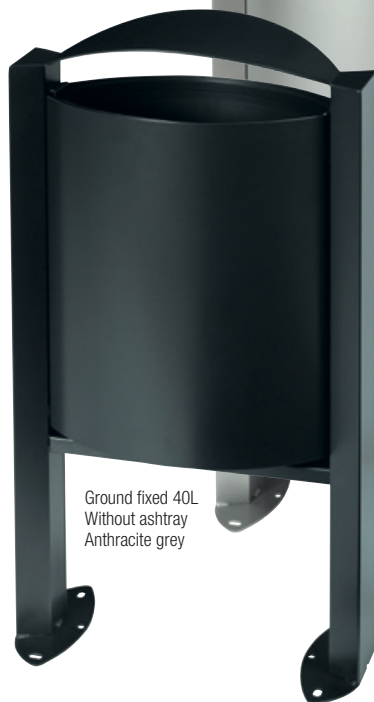

Ground fixed 40L  
Without ashtray  
Anthracite grey



Ashtray 3L  
1800 butts



Bag clamps to facilitate  
insertion and removal  
of the bag

## ARKEA

### WALL-MOUNTED OR GROUND FIXED

- Anti-corrosion treated and anti-UV powder-coated steel.
- Discrete keyless locking system (internal push button)
- For wall-mounted bins: 4-point wall-mounting system
- For ground fixed bins: 4-point floor-anchoring system
- Easy to open by tilting the bucket forward
- Reduced opening to prevent the insertion of bulky objects

### ACCESSORIES

#### INNER BUCKET 40L AND 60L

- Galvanised steel
- Gripping handle
- Perforated bottom for liquid evacuation

Ref. 58871 - 40L Ref. 58872 - 60L

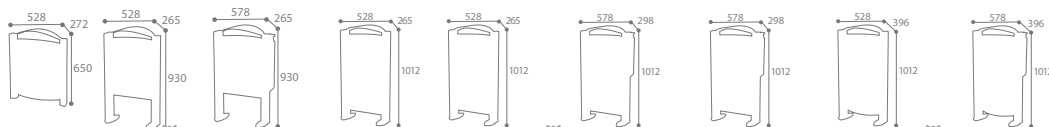

	50L			110L				130L	
Colour	Wall-mounted 40L	Ground fixed 40L	Ground fixed 40L + ashtray 3L*	Ground fixed 60L	Ground fixed 60L VIGIPIRATE	Ground fixed 60L + ashtray 3L*	Ground fixed 60L + ashtray 3L* VIGIPIRATE	Ground fixed 100L	Ground fixed 100L + ashtray 3L*
Cement grey RAL 7033	56300	56305	56535	56320	56343	56525	56296	58514	56283
Metal grey RAL 9006	56303	56308	56538	56323	56344	56528	56278	58513	56276
Manganese grey	56304	56309	56539	56324	56341	56529	56277	58510	56275
Anthracite grey RAL 7016	56245	56246	56249	56247	56248	56250	56284	58518	56279

### ACCESSORIES

#### ARKEA

#### PACK OF 2 PLASTIC PANELS + PEST CONTROL BASE PLATE FOR VIGIPIRATE ANTI-TERRORISM BIN

- Transparent polycarbonate panels: Impact resistant
- Base plate in anticorrosion treated steel
- Pest control base plate

Ref. 56346 - Pack of 2



#### EXAMPLE OF COMPOSITION



\* "Cigarette" sticker supplied





# Urbanet UNBEATABLE



## URBANET

### WALL-MOUNTED 30L OR GROUND FIXED 60L BIN

- Anti-corrosion treated and anti-UV powder-coated steel
- Honeycomb front to deter illegal posting and tagging
- Discreet keyless locking system (inside latch)



Front opening and bag holder

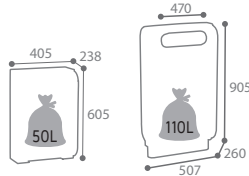

Colour	Wall-mounted 30L	Ground fixed 60L
■ Metal grey RAL 9006	56233	56238
■ Manganese grey	56234	56239
■ Anthracite grey RAL 7016	56220	56223
■ Corten effect	56222	56225



Wall-mounted 30L Anthracite grey

Ground fixed 60L Metal grey

Ground fixed 60L Corten effect

## ACCESSORIES

### INNER BUCKET 30L AND 60L

- Galvanised steel
- Lateral handles for easy grip

- Ref. 59351 - Galvanised steel - 30L
- Ref. 59356 - Galvanised steel - 60L

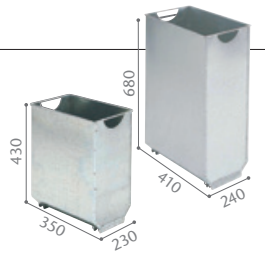

Vigipirate national security alert: the inner bucket can be turned over to block the bin as and when required.

# Urbis

THE MUST-HAVE



## URBIS

### FREE-STANDING OR GROUND-ANCHORED BIN 60L

- Anti-corrosion treated and anti-UV powder-coated steel
- Lid with 90° angular deflection
- Lid locked using a triangular key lock
- 4-point ground-anchoring system possible
- Inner galvanised steel bucket 60L

- Ref. 56205 - Manganese grey
- Ref. 56206 - Anthracite grey RAL 7016
- Ref. 56207 - Corten effect

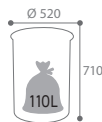

Manganese grey

Corten effect

Anthracite grey



CUSTOMISATION AVAILABLE SUBJECT TO QUOTATION



Urban Furniture Urban bin



# Piz ROBUST



Bag holder to facilitate bag removal

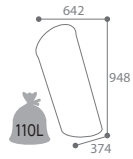
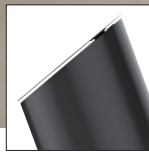

## PIZ PIZ EXTREME GROUND-ANCHORED BIN 85L

- PIZ PREMIUM: corrosion-proof, anti-UV powder-coated steel
- PIZ EXTREME: corrosion-proof, anti-UV powder-coated, hot-dip galvanised steel\*\*
- 20° slant
- Thermo-coated stainless steel lid with a reinforced hinge
- Reduced opening to prevent the insertion of bulky objects
- 3-point floor-anchoring system
- Spacers to avoid contact with the ground
- Slanted bag holder to facilitate bag removal

Colour	PREMIUM	EXTREME
■ Manganese grey	56202	56201



CUSTOMISATION AVAILABLE SUBJECT TO QUOTATION

# Elice



## ELICE

### VIGIPIRATE SECURITY BIN - 110L

- ELICE PREMIUM: corrosion-proof, anti-UV powder-coated steel
- ELICE EXTREME: corrosion-proof, anti-UV powder-coated, hot-dip galvanised, steel\*\*
- Bag held inside the bin via 4 rings and 4 steel uprights
- Steel uprights reinforce the structure
- Vandal-proof: ground-anchored on 4-point plate

Colour	PREMIUM	EXTREME
■ Manganese grey	56317	56315



### ELICE EXTREME

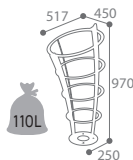

2 stainless steel Bag clamps to facilitate insertion and removal of the bag

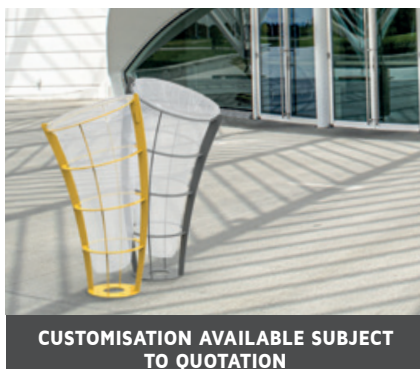

CUSTOMISATION AVAILABLE SUBJECT TO QUOTATION





# Ecollecto Collecmur Extreme



## ECOLLECTO EXTREME COLLECTMUR EXTREME

### WALL MOUNTED BAG HOLDER WITH OR WITHOUT LID - 110 L

- Treated with anti-corrosion primer, anti-UV powder-coated, hot-galvanised steel\*\*
- Bag held in place by an elastic strap
- Wall-mounted system: 1 optional plate to facilitate installation (see p35)
- Post-mounted: clamp supplied (post optional, see p34)

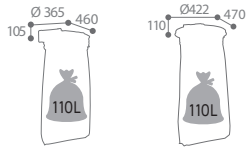

Colour	ECOLLECTO EXTREME WITHOUT LID	COLLECTMUR EXTREME WITH LID
■ Hot-dip galvanised	57118	57798
■ Manganese grey	57831	57806



DISCOVER ALL OF OUR "SPECIAL WASTE SORTING" BAG AND ACCESSORY HOLDERS ON PAGES 32 TO 35

# Ecollecto

# Collecmur



### SACK HOLDER ON POST WITH FLOOR ANCHORED PLATE - 110L

- ESSENTIEL model: anti-UV powder-coated steel
- EXTREME model: treated with anti-corrosion primer, anti-UV powder-coated, hot-galvanised steel\*\*
- Thick reinforced base plate (4mm)
- Delivered assembled
- Vandal-proof: 3-point floor-anchoring system
- Bag held by elastic strap



Colour	ECOLLECTO WITHOUT LID		COLLECTMUR WITH LID	
	Essentiel	Extreme	Essentiel	Extreme
■ Moss green RAL 6005	57319	57821	56850	57644
■ Manganese grey	57765	57822	56846	57645

\* Subject to compliance with installation and maintenance guidelines. \*\* The product may develop an uneven surface as a result of the treatment.



Urban Furniture Urban bin



# Tulipe IDEAL FOR URBAN LANDSCAPES



Bag clamps make it easy to insert and remove the bag



## TULIPE BIN - 35L

- Anti-corrosion treated and anti-UV powder-coated steel
- Wall / post mounted (post supplied separately)
- Integrated bag clamp

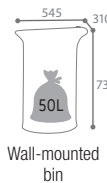

Wall-mounted bin

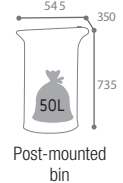

Post-mounted bin

Colour	Wall-mounted bin	Post mounted bin
■ Olive green RAL 6003	57988	57946
■ Moss green RAL 6005	58375	57945
■ Manganese grey	58409	57949
■ Anthracite grey RAL 7016	58432	58434



Wall-mounted Olive green

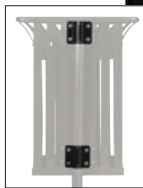

Post-mounted with fixing clamps supplied



Post-mounted Manganese grey

Two bins can be placed back-to-back for waste sorting (see Accessories p34/35)

## ACCESSORIES

### COLLEC POST

- Anti-UV powder-coated steel
- Floor anchored post for post-mounted bin
- Ref. 57841 - Manganese grey

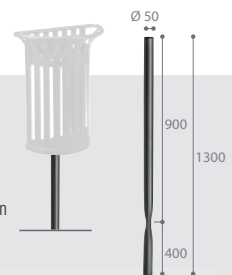

Discover all our posts (p34)



## BESTSELLER

### TULIPE

#### BIN - 60L

- Anti-corrosion treated and anti-UV powder-coated steel
- Inner bag holder
- ground-anchored or free-standing
- Optional inner bucket

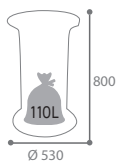

Colour	Bin	Vigipirate security bin
■ Olive green RAL 6003	57986	59141
■ Moss green RAL 6005	57997	59140
■ Manganese grey	58063	59142
■ Anthracite grey RAL 7016	58443	59143



Standard - Anthracite grey



Vigipirate Security - Moss green



Bag clamps to facilitate insertion and removal of the bag

## ACCESSORIES

### TULIPE INNER BUCKET 40 L

- Galvanised steel
- Gripping handle
- Perforated base (for evacuation of liquids)

■ Ref. 58061 - Galvanised steel



Discover our new TULIPE 2-stream bins (p31)

# Arkea



## ARKEA

### WALL MOUNTED REMOVABLE BIN 20L AND 40L

- Anticorrosion treated, anti-UV powder coated steel or brushed stainless steel AISI 304 (18/10)
- Unhook to empty
- Wall-mounting spacers supplied

Coloris	20L	40L
■ Cement grey RAL 7033	58395	58400
■ Metal grey RAL 9006	58398	58403
■ Manganese grey	58399	58404
■ Brushed stainless steel	56870	56872
□ Traffic white RAL 9016	56869	56871
■ Anthracite grey RAL 7016	58338	58337

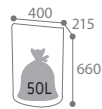
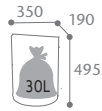

Locking latch under the bin (padlock not supplied)



40L - Anthracite grey



20L - White

### ACCESSORIES

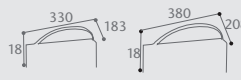

#### BAG CLAMP

- Ref. 56578 - 20L
- Ref. 56579 - 40L

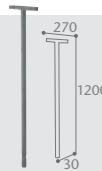

#### POST FOR GROUND ANCHORING

- Ref. 57041 - Manganese grey



TRY A LITTLE COLOUR! CUSTOMISABLE SUBJECT TO ESTIMATE - DISCOVER OUR STANDARD COLOURS P8

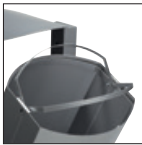

Bag clamps to facilitate insertion and removal of the bag

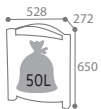

Manganese grey



## ARKEA

### WALL-MOUNTED BIN - 40L

- Anti-corrosion treated and anti-UV powder-coated steel
- Discreet keyless ashtray locking system
- 4-point wall-mounting system
- Easy to open by tilting the bucket forward
- Reduced opening to prevent the insertion of bulky objects

- Ref. 56300 - Cement grey RAL 7033
- Ref. 56303 - Metal grey RAL 9006
- Ref. 56304 - Manganese grey
- Ref. 56245 - Anthracite grey RAL 7016

Full Arkea range (p46)



### ACCESSORIES

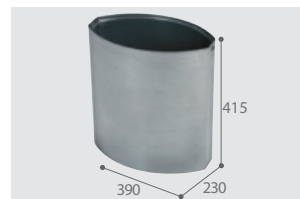

#### INNER BUCKET - 40L

- Galvanised steel
- Gripping handle
- Perforated base for evacuation of liquids
- Ref. 58871 - 40L

# Tourny PIVOTING



Grey metal on post



Cement grey

Metal grey



## TOURNY

### WALL MOUNTED RECTANGULAR PIVOTING BIN - 27L

- Anti-UV powder-coated steel.
- Removal by tipping/latch lock
- Perforated base for evacuation of liquids
- Installation in a covered area

- Ref. 58385 - Cement grey RAL 7033
- Ref. 58388 - Metal grey RAL 9006
- Ref. 58381 - Manganese grey

### ACCESSORIES

#### POST FOR PIVOTING BIN

- Anti-UV powder-coated steel
- ground-anchored post

- Ref. 58870 - Manganese grey





# Korok

## CHOOSING YOUR WHEELIE BIN

7 capacities	Number of wheels	Accessories			
		Front rail*	Tow bar	Forklift stirrups	wheelie bin enclosure
• 80L	• 2 wheels	✓	-	✓	✓
• 120L		✓	-	✓	✓
• 240L		✓	-	✓	✓
• 340L	• 4 wheels	✓	-	✓	✓
• 660L		✓	✓	✓	✓
• 770L		✓	✓	✓	✓
• 1000L		✓	✓	✓	✓

\*According to the colour of the lid



80L  
With front rail

80L  
Without front rail



4 wheels - 1000L  
With front rail

Solid rubber swivel wheels with polypropylene rims (including 2 wheels with brake for the 4-wheel models)

## KOROK

### 2 OR 4 WHEEL COUNTAINER

- Virgin high-density polyethylene **100% recyclable**
- 2 WHEELS: Emptied from the front
- 4 WHEELS: Emptied from the front or side DIN (trunnion)
- Grey body
- Complies with standard EN-840 1-6

## FRONT RAIL AVAILABLE ON ALL THE SIZES

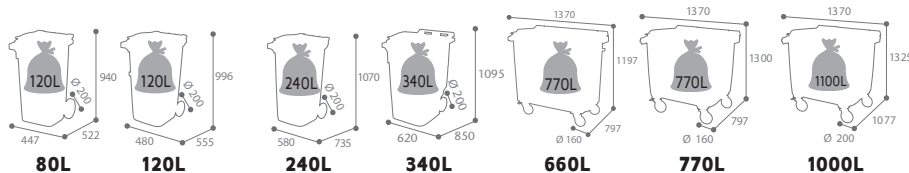

Colour	2 WHEELS				4 WHEELS		
	80L	120L	240L	340L	660L	770L	1000L
Grey/Grey - Without rail	56608	56663	56620	56630	56640	56650	56660
Grey/Grey - Front rail	56609	56670	56625	56635	56645	56655	56665
Grey/Yellow - Without rail	-	56664	56621	56631	56641	56651	-
Grey/Yellow - Front rail	-	56671	56626	56636	56646	56656	-
Grey/Blue - Without rail	-	56666	56622	56632	56642	56652	-
Grey/Blue - Front rail	-	56672	56627	56637	56647	56657	-
Grey/Green - Without rail	-	56667	56623	56633	56643	56653	-
Grey/Green - Front rail	-	56673	56628	56638	56648	56658	-



Integrated handle



Noise-damping lid



Lid that tilts back completely



Draining plug to facilitate cleaning

OTHER COLOURS AVAILABLE - MIN 40 UNITS : CONTACT US ON +33 2 43 01 55 55



IMPROVES USERS QUALITY OF LIFE

**NEW**

**ACCESSORIES**



FACILITATES THE MOVING OF SEVERAL WHEELIE BINS AT ONE TIME

**KOROK**

**TOW BAR FOR TWIN AXEL WHEELIE BIN**

- Zinc plated steel
- Can be fitted without drilling using the wheel attachment
- Fittings supplied
- Creates a train of KOROK wheelie bin
- Delivered unassembled

- Ref. **53980** - Tow bar for KOROK 660L and 770L
- Ref. **53981** - Tow bar for KOROK 1000L



Optimal air circulation



120L



**KOROK BIOWASTE**

**SINGLE AXEL BIOWASTE WHEELIE BIN**

- 100% recyclable virgin high density polyethylene
- Emptied from the front
- Complies with standard EN-840 1
- 2 side vents on the tub to facilitate drying and reduce bad odours

- Ref. **59607** - Brown - 120 L - Without rail
- Ref. **59608** - Brown - 240 L - Without rail



For our wheelie bin concealers (p39-40)



ENABLES THE MOVING AND EMPYING OF THE WHEELIE BIN

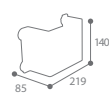

Set for 2 wheels

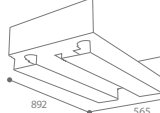
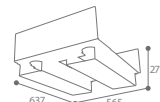

Set for 4 wheels



**KOROK**

**FORKLIFT STIRRUPS FOR SINGLE & TWIN AXEL WHEELIE BINS**

- Galvanised steel
- 2 wheels: fixed to the front facade
- 4 wheels: fixed to the undercarriage
- Screws and drilling templates supplied
- Delivered unassembled

- Ref. **53982** - kit for 2 wheels - 80L à 340L
- Ref. **53983** - kit for 4 wheels- 660L et 770L
- Ref. **53984** - kit for 42 wheels - 1000L

PROTECTS AGAINST IMPACT AND LIMITS MOVEMENT



**KOROK**

**WHEELIE BIN ENCLOSURE - SINGLE/TWIN AXEL**

- Galvanised steel
- Galvanised steel tube Ø48mm
- 2 rotating arms
- 9 point ground fixing
- Delivered unassembled

- Ref. **54477** - Enclosure for single axel - 80L to 340L
- Ref. **54478** - Enclosure for twin axel - 660L to 1000L





# Eden Etik

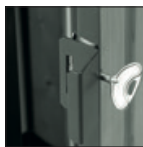

Vandal-proof: key locking system

ROBUST



Practical: emptied from the front

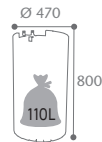

## COLLEC ETIK ETIK SURROUND

- Slats made from recycled food cartons
- Frame and fasteners in stainless steel AISI 304 (18/10)

Ref. 57792 - Grey recycled slats

Ref. 54140 - Brown recycled slats **NEW**



**NEW**

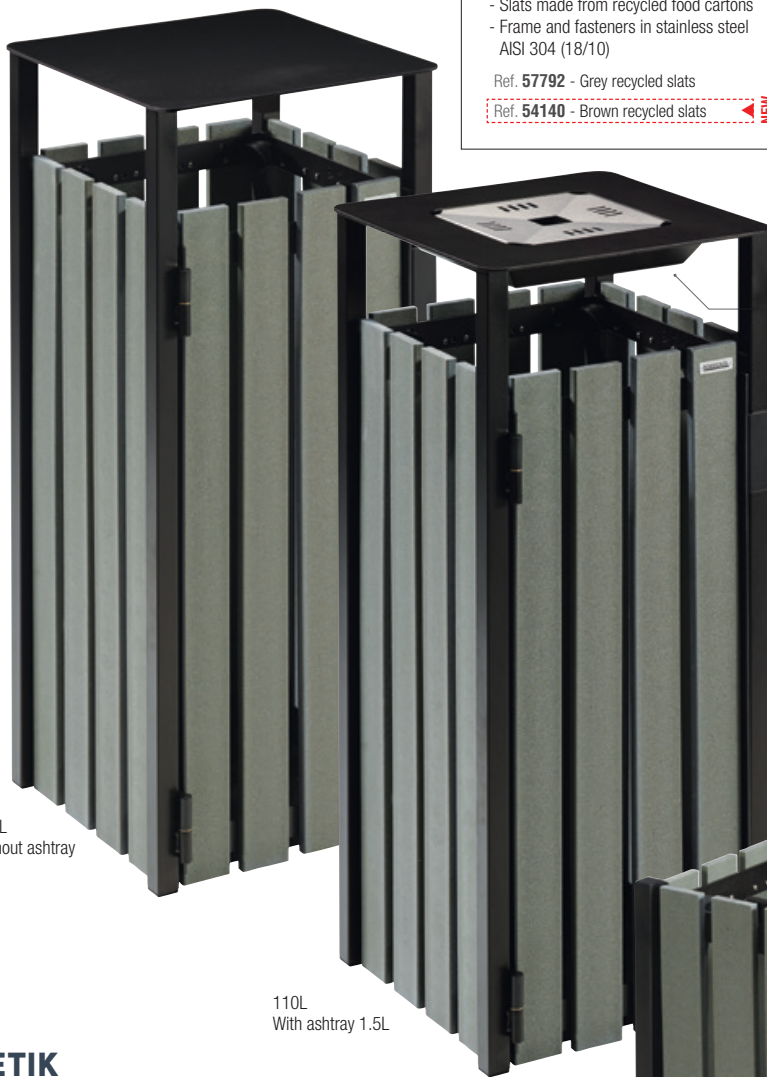

110L  
Without ashtray

110L  
With ashtray 1.5L

Ashtray 1.5L

900 butts



CUSTOMISATION AVAILABLE SUBJECT TO QUOTATION



## EDEN ETIK

### FREE-STANDING OR GROUND FIXED BIN - 50L AND 110L

- Structure and lid: Anti-corrosion treated and anti-UV powder-coated steel
- Slats made from recycled food cartons
- Bag held by 2 "Bag clamps"
- Can be fixed to ground anchoring feet (optional 58155 - See p58)
- Cigarette stub out grid (model with ashtray only) in AISI 304 brushed stainless steel (18/10)

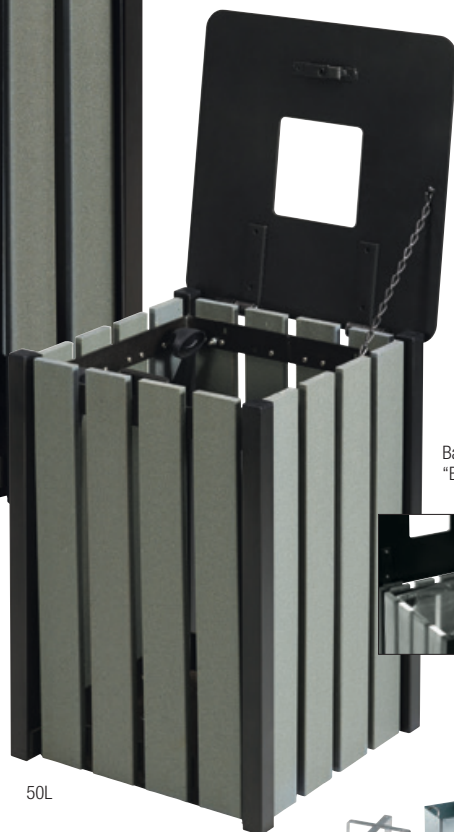
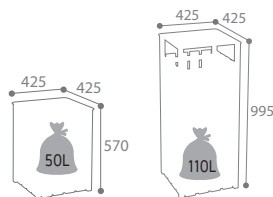

Bag held by 2 "Bag clamps"

50L

Colour	50L		110L	
	Without ashtray	Without ashtray	With ashtray	With ashtray
■ Manganese grey	59265	59270	59275	59275

Discover the EDEN accessories (p59)

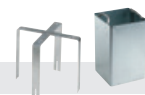





## WASTE SORTING IDENTIFICATION



### ZENO ETIK

#### FREE-STANDING OR FIXED BIN - 40L AND 60L

- Structure and lid in anticorrosion treated, anti-UV powder coated steel
- Slats made from recycled food cartons
- Triangular key-lock
- 2 reduced side openings limiting the introduction of bulky objects
- Galvanised steel inner bucket with handle included
- Inner bucket in galvanised steel with a metal handle
- Coloured lid adaptable to different sorting types
- Vandal-proof: 3-point floor-anchoring system

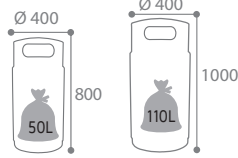

Lid Colour	40L	60L
<b>Grey slats</b>		
Colza yellow RAL 1021	57934	57935
Ultramarine RAL 5002	57928	57929
Manganese grey	57932	57933
<b>Brown slats</b>		
Colza yellow RAL 1021	54142	54145
Ultramarine RAL 5002	54143	54146
Manganese grey	54141	54144

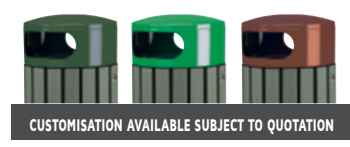

CUSTOMISATION AVAILABLE SUBJECT TO QUOTATION



Ashtray 3L  
1800 butts



Ashtray 3L  
1800 butts

### ARKEA ETIK

#### GROUND FIXED BIN - 60L

- Structure in anticorrosion treated, anti-UV powder coated steel
- Slats made from recycled food cartons
- Facades tip forward facilitating emptying
- Discreet keyless ashtray locking system
- 4-point floor-anchoring system
- Reduced opening to prevent the introduction of bulky objects

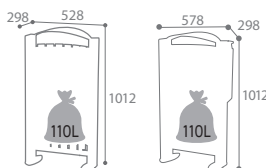

- Ref. 59280 - Manganese grey - Without ashtray
- Ref. 59281 - Manganese grey - With ashtray 3L

### ARKEA ETIK

#### ARKEA ETIK GROUND FIXED BIN - 2X60L

- Structure in anticorrosion treated, anti-UV powder coated steel
- Slats made from recycled food cartons
- Discreet keyless ashtray locking system
- 4-point floor-anchoring system
- Supplied with stickers to be stuck to the facades (Recyclable/Non Recyclable)

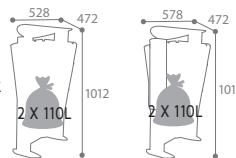

Colour	Without ashtray	With ashtray 3L
Cement grey RAL 7033	59285	59315
Colza yellow RAL 1021		

For our 2x60L ARKEA METAL (P30) and ARKEA WOOD (P 58)



# Urban Furniture Urban bin



## CHOOSE YOUR ZENO BINS

Size	Lid type	Tub
40L	• 2 side openings	• Wood
60L	• 2 side openings	• Wood • Aluminium • Extreme
	• 2 side openings	• Aluminium • Extreme
80L	• Closed lid	• Wood
	• Funnel type lid	



Version EXTREME

## Zeno ALU slats



### ZENO ALU ou ZENO EXTREME

FREE-STANDING OR FIXED BIN 60L AND 80L

- **Zeno ALU:** Anti-corrosion treated and anti-UV powder-coated steel structure and lid
- **Zeno EXTREME:** Structure and lid in anticorrosion treated, anti-UV powder coated galvanised steel
- Triangular key-lock
- 2 reduced side opening to limit the introduction of bulky objects
- Bag holder in stainless steel facilitating bag insertion and removal
- Vandal-proof: 3-point floor-anchoring system
- Optional inner bucket

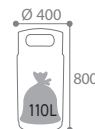

60L



80L

	ALU		EXTREME	
Slats-Corten effect	60L	80L	60L	80L
■ Manganese grey	57580	57579	57589	57588

### LEVEL SENSOR FOR ZENO EXTREME

Track the level of your bin in real time

- Analyse your data
- Receive an alert when your bin is full
- Optimise your rounds
- Reduce your costs

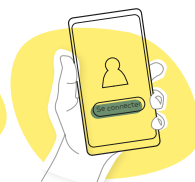
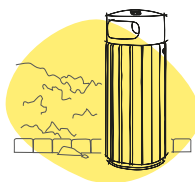

Discover our connected service (p2-3)

### OPTION

#### INNER BUCKET 40L AND 60L

- Galvanised steel
- Gripping handle
- Vent Holes for easy bag removal

- Ref. 57575 - 40L - For ZENO 60 L bin
- Ref. 57574 - 60L - For ZENO 80 L bin

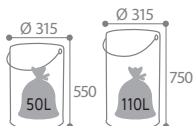

Vigipirate national security alert: the inner bucket can be turned over to block the bin as and when required.

\* Subject to compliance with installation and maintenance guidelines.

# Zeno WOODEN slats



## ZENO WOOD PROTEC

### FREE-STANDING OR GROUND-ANCHORED BIN 80L

- Anti-corrosion treated and anti-UV powder-coated structure and lid
- Galvanised version: hot galvanised steel structure and lid
- Lid without apertures
- Varnished wooden slats in accordance with the FSC standard
- Bag holder in stainless steel facilitating bag insertion and removal
- Vandal-proof: 3-point floor-anchoring system
- Optional inner bucket (60L)

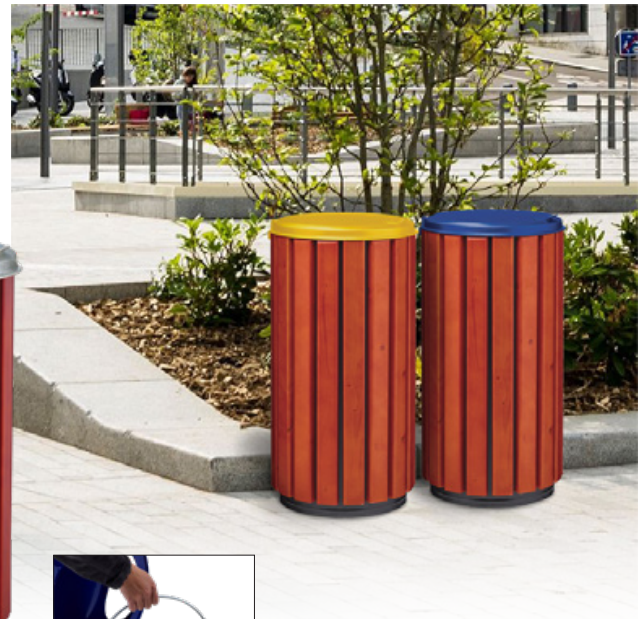
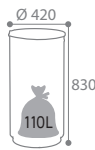

Lid Colour	80L
■ Manganese grey	57602
■ Colza yellow RAL 1021	57592
■ Ultramarine blue RAL 5002	57593
■ Galvanised steel	57603
■ Galvanised steel - Manganese grey	57594



Delivered with galvanised steel inner bucket



## ZENO WOOD ACCESS

### FREE-STANDING OR FLOOR-ANCHORED BIN 80L

- Anti-corrosion treated and anti-UV powder-coated structure and lid
- Galvanised version: hot galvanised steel structure and lid
- Funnel shaped lid
- Varnished wooden slats in accordance with the FSC standard
- Triangular key lock
- Bag holder in stainless steel facilitating bag insertion and removal
- Vandal-proof: 3-point floor-anchoring system
- Optional inner bucket (60L)

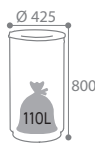

Lid Colour	80L
■ Manganese grey	57604
■ Colza yellow RAL 1021	57605
■ Ultramarine blue RAL 5002	57623
■ Galvanised steel - Manganese grey	57622



CUSTOMISATION AVAILABLE  
SUBJECT TO QUOTATION



## ZENO WOOD

### FREE-STANDING OR FLOOR ANCHORED BIN 40L AND 60L

- Structure and lid in anticorrosion treated, anti-UV powder coated steel
- Wooden slats
- Triangular key-lock
- 2 reduced side openings limiting the introduction of bulky objects
- Vandal-proof: 3-point floor-anchoring system

Lid Colour	40L	60L
■ Manganese grey	57996	58210
■ Colza yellow RAL 1021	57881	57884
■ Ultramarine blue RAL 5002	57882	57885

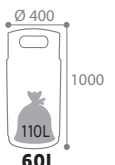

## OPTION

### INNER BUCKET 60L

- inner bucket in galvanised steel
- Option for ZENO PROTEC and ZENO ACCESS
- Gripping handle
- Vent holes for easy bag removal
- Ref. 57574 - 60L - For ZENO 80L bin

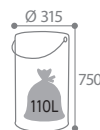



# Arkea



Olive green



## ARKEA FREE-STANDING WOOD FRONTED BIN - 60L

- Anti-corrosion treated and anti-UV powder-coated steel
- "Autoclave" treated softwood slats, certified "Class 4"

- Ref. 56339 - Wood/Olive green RAL 6003
- Ref. 56340 - Wood/Moss green RAL 6005
- Ref. 56328 - Wood/Manganese grey



Facades tip forward facilitating emptying

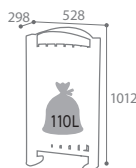

Option with ashtray on request



Moss green



## ARKEA FREE-STANDING WOOD-FRONTED BIN 2X60L

- Anti-corrosion treated and anti-UV powder-coated steel
- Front with "autoclave" treated slats: "Class 4" certified wood
- Open by tilting the facades forward
- Discreet keyless ashtray locking system
- 2 coloured signage plates attached to the facades to identify waste type
- Supplied with stickers to be placed on the signage plate (Recyclable / Non Recyclable)



Bag clamps to facilitate insertion and removal of the bag



Straps keep the facades in place

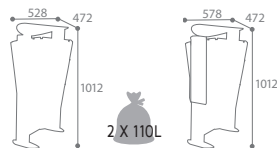

Ashtray 3L

1800 butts

Body colour Manganese grey	Without ashtray	With ashtray
■ Cement grey RAL 7033	56366	56369
■ Colza yellow RAL 1021		

### CERTIFICATION

#### SOFTWOOD CERTIFIED "CLASS 4"

The treatment system is known as autoclave, arsenic-free, in accordance with new European environmental directives. The treatment impregnates the wood to the core, making it rot-proof: resistant to rotting, insects and fungi. It gives the wood a slightly greenish colour that fades with time.



All our wood products comply with the ministerial directive on the promotion of sustainable forest management (decrees of 05/04/05).



With ashtray 3L



Discover our ARKEA 2-bin system in METAL and ETIK (p30)



# Eden

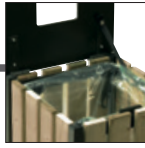

Bag held by 2 stainless steel Bag clamps



## EDEN

### FREE-STANDING OR FLOOR ANCHORED BIN 50L AND 110L

- Anti-corrosion treated and anti-UV powder-coated steel
- "Autoclave" treated softwood slats, certified "Class 4"
- Cigarette stub-out grid (model with ashtray only) made of AISI 304 brushed stainless steel (18/10)

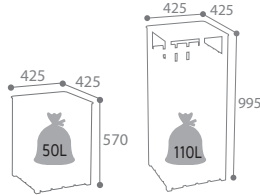

	50L	110L	
Colour	Without ashtray	Without ashtray	With ashtray
■ Olive green RAL 6003	57875	57876	56395
■ Moss green RAL 6005	57874	57877	56396
■ Manganese grey mat lisse	57873	57878	56397

110L Without Ashtray Olive green



Ashtray 1.5L 900 butts

110L With ashtray 1.5L Manganese grey

50L Moss green

## ACCESSORIES

### ANCHORING FEET FOR EDEN BIN 50L AND 110L

- Base and anchors made of galvanised steel
- Reinforced floor anchoring

■ Ref. 58155 Galvanised steel

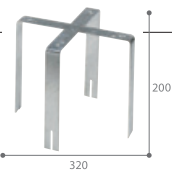

### INNER BUCKET FOR BIN 50L

- Galvanised steel
- Perforated base (for evacuation of liquids)
- Carrying handle

■ Ref. 56781 Galvanised steel



# Eden CERTIFIED CLASS 4

Certification see p58



Bag held by "Bag clamps"



Easy emptying by removing the bucket (optional)



## EDEN

### WALL-MOUNTED BIN - 20L

- Structure in anti-corrosion treated steel
- "Autoclave" treated softwood slats, certified "Class 4"
- Post-mounting possible

Ref. 58150 - Softwood

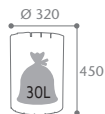

## ACCESSORIES

### EDEN - INNER BUCKET FOR 20L BIN

- Galvanised steel
- Perforated base (for drainage of liquids)
- Gripping handle

■ Ref. 56780 - Galvanised steel



Practical: emptied from the front

### EDEN - GROUND ANCHORED POST FOR WALL MOUNTED BIN

- "Autoclave" treated softwood slats, certified "Class 4"
- Floor-anchoring

Ref. 57834 - Softwood



## COLLEC

### WOOD SURROUND

- "Autoclave" treated softwood slats, certified "Class 4"
- Frame and fasteners in stainless steel AISI 304 (18/10)

Ref. 57800 - Softwood

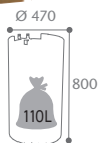
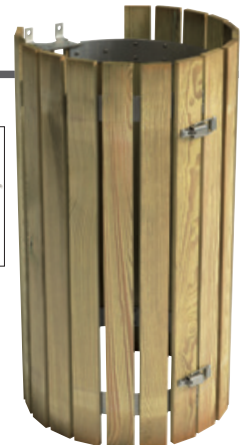

### EDEN - POST MOUNTING KIT

- Anticorrosion treated and anti-UV powder coated steel (stainless steel nuts + bolts)
- Enables EDEN bin to be mounted on the HYGEC post

- Ref. 59817 - Olive green RAL 6003
- Ref. 59814 - Moss green RAL 6005
- Ref. 59816 - Manganese
- Ref. 59833 - Anthracite grey RAL 7016



### COMPOSITION



57841 58223 57800



# Mobisac EASY COLLECTION AND SORTING

Easy placement of bags

**MOBISAC**  
**STREET CLEANING BARROW 2X110L**

- Powder-coated steel
- 2 bag clamps on each sack holder
- 2 storage compartments for accessories
- 1 practical tool storage compartment
- Lid with grip stopper and noise dampers
- Product delivered assembled and can be dismantled
- Sold without accessories (no spade or brush)

**TROLLEY 2-STREAM**

- Ref. 57228 - No lid - Solid rubber wheels
- Ref. 57229 - No lid - Pneumatic wheels
- Ref. 57226 - With lid - Solid rubber wheels
- Ref. 57227 - With lid - Pneumatic wheels

Twin sack holder barrow without lid, with pneumatic wheels

Twin sack holder barrow with lid, with solid rubber wheels



Easy opening and bag placement



Solid rubber wheels



Pneumatic wheels



1 practical tool storage compartment



## MOBISAC

### STREET CLEANING BARROW 110L

- Powder-coated steel
- Bag held by an elastic strap
- 2 storage compartments for "accessories"
- Sold without accessories (no spade or brush)

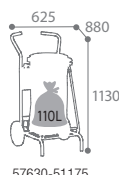

57630-51175

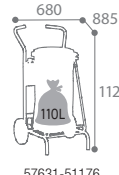

57631-51176

- Ref. 57630 - Moss green RAL 6005 - With lid - Solid rubber wheels
- Ref. 57631 - Moss green RAL 6005 - With lid - Pneumatic wheels
- Ref. 57175 - Moss green RAL 6005 - No lid - Solid rubber wheels
- Ref. 57176 - Moss green RAL 6005 - No lid - Pneumatic wheels

Trolley with pneumatic wheels



## XERIOS

### WALL-MOUNTED BIN - 50L

- Polypropylene
- Tub can be removed
- Wall- or pole-mounted
- Metal lock and plastic key
- Stainless steel cigarette stub plate for extinguishing cigarettes

- Ref. 59858 - Orange
- Ref. 59861 - Grey head/Green body
- Ref. 59864 - Green head/Grey body
- Ref. 59866 - Green head/Green body
- Ref. 59868 - Green head/Grey body

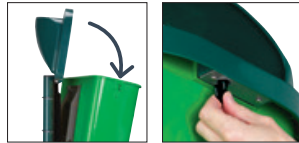

Easy to empty by simply unhooking the tub

Key opening mechanism



## PROXIMI "GREEN"

### WALL-MOUNTED BIN - 23L

- Anti-UV treated **recycled** and **recyclable** polypropylene
- Wall mounted or post mounted (see P.31)
- Supplied with 2 jubilee clips

- Ref. 59718 - Green

## ACCESSORIES

### COLLEC CONCRETE IN POST

- Ref. 57841 - Manganese grey



### COLLEC POST CENTERED ON A FLOOR ANCHORED PLATE

- Ref. 56873 - Manganese grey

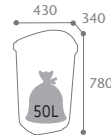
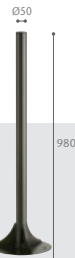

For our range of dog hygiene products P62



## XERIOS "GREEN"

### WALL-MOUNTED BIN - 50L

- Recycled **polypropylene**
- Tub can be removed
- Wall- or post-mounted
- Key opening mechanism
- Stainless steel cigarette stub plate for extinguishing cigarettes

- Ref. 54990 - Grey head / Grey-green body

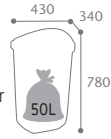

## BAZI "GREEN"

### STREET BINS 50L, 70L AND 95L

- **Recycled** polyethylene
- Lid with locking system
- 2 ergonomic handles

- Ref. 57610 - Black - 50L
- Ref. 57611 - Black - 70L
- Ref. 57612 - Black - 95L

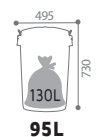
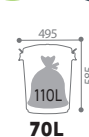

## INTEGRATED HANDLES FOR EASY TRANSPORT



## REGLISSE "GREEN"

### BATCH OF 6 STREET BINS 80L

- **Recycled** high-density polyethylene (HDPE)
- Lid with locking system

- Ref. 91996 - Black



X6

## ACCESSORIES

## BAZI "GREEN"

### DOLLY FOR 50L 70L AND 95L BIN

- Facilitates handling of the bin when full
- 5 castors - integrated brake
- Attached by quarter turn

- Ref. 57634 - Black





Urban Furniture Dog hygiene



# Hygeca

## HYGECA

### DOG HYGIENE DISPENSER AND OPTIONAL STAND

- Anti-corrosion treated and anti-UV powder-coated steel
- Front opening and key lock
- **Version 400 bags/2 rolls:** twin dispenser for bags on a roll, flow regulator to facilitate single bag dispensing
- **500-bag bundle version:** Bags held in place by a hook



Dispenser  
400 bags/  
2 rolls  
Manganese  
grey



Dispenser  
500-bag bundle  
Moss green

## HYGECA

### WALL OR POST (Ø50MM) MOUNTED DOG HYGIENE DISPENSER

- 4 point wall mounting, or post (Ø50mm) - post fixings supplied

Colour	400 bags/ 2 rolls	500-bag bundle
■ Olive green RAL 6003	59911	59811
■ Moss green RAL 6005	59910	59812
■ Manganese grey	59912	58683
■ Anthracite grey RAL 7016	59923	59928

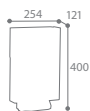

## CONSUMABLES

### DOOGY **NEW** PAPER BAGS (BUNDLE)

- Brown kraft paper - 35gr/m<sup>2</sup>
- 100% biodegradable, 100% compostable
- Non toxic water based white ink
- Bundles held together by recycled paper header pack
- Hook slots in the header pack to keep the bundle in place for easy dispensing
- PEFC paper issued from local and responsibly managed forests.
- Large opening for optimal use
- EN 13432:200 meets the requirements of the European packaging directive (94/62/EC)
- Size: single bag 365x200x10mm

TEAR AND MOISTURE  
RESISTANT, LEAKPROOF



Ref. 53020 - Pack of 1,000 bags - 20 bundles (1 bundle = 50 bags)

### DOOGY BAGS ON A ROLL

- Bags with handles for dog waste in polyethylene HD 15µ
- Bags pre-cut at handle level
- Screen printed instructions for use
- Dim. Roll: 205 x Ø70 mm

Ref. 55171 - Pack of 2,000 bags - 10 rolls  
Ref. 55172 - Pack of 5,000 bags - 25 rolls  
(1 roll = 200 bags)



### DOOGY BAGS IN A BUNDLE

- Dog waste bags made of polyethylene HD 12µ
- Perforated fastener strip and pre-cut bags
- Screen printed instructions for use
- Bundle size: 400 x 180 mm

Ref. 55161 - Pack of 500 bags = 5 bundles  
Ref. 55174 - Pack of 5,000 bags = 50 bundles  
(1 bundle = 100 bags)

Compatible with all the dispensers on the market



LIMITS BAG  
CONSUMPTION

Easy fitting of bag  
bundles



Easy insertion of the  
2 rolls



Economical thanks to  
the roll flow regulator

CUSTOMISATION AVAILABLE  
SUBJECT TO QUOTATION

## HYGECA

### CONCRETE IN DOG HYGIENE DISPENSER AND STAND

- Composition of the concrete in kit: signage+dispenser+post
- Possible to add a bin or sack holder to the HYGECA post

Colour	400 bags/ 2 rolls	500-bag bundle
■ Olive green RAL 6003	59915	59810
■ Moss green RAL 6005	59916	59813
■ Manganese grey	59914	58682
■ Anthracite grey RAL 7016	59918	59920

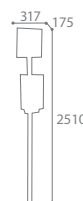





# Arkea Canin



ECONOMIC DISTRIBUTION



## ARKEA CANIN OR ARKEA CANIN EXTREME

### DISPENSER - 200 BAGS

**Arkea Canin:** Anti-corrosion treated and anti-UV powder-coated steel  
**Arkea Canin EXTREME:** Dispenser is made of anticorrosion treated, anti-UV powder coated stainless steel  
 Stand, brackets and plates made of corrosion-proof, anti-UV powder-coated, hot-dip galvanised steel

- **Wall-mounted:** 2-point anchoring system
- **Free-standing:** 3-point floor-anchoring system
- **For posts:** brackets supplied to fit Ø50mm post (to be bought separately)
- Screenprinted instructions
- Pack of 200 optional rolls of bags (Ref. 55171 or 55172) see p62



Loading by simple unhooking

Colour	Wall-mounted	For post-mounting	Ground fixed
<b>ARKEA CANIN</b>			
■ Manganese grey	59155	59181	59171
■ Metal grey RAL 9006	59156	59182	59172
■ Corten effect	59157	59183	59173
■ Anthracite grey RAL 7016	59158	59184	59174
<b>ARKEA CANIN EXTREME</b>			
■ Manganese grey	54605	54606	54607

### ACCESSORIES

#### INFORMATION PLATE FOR A POST

- **Arkea Canin** Anti-corrosion treated and anti-UV powder-coated steel
- **Arkea Canin EXTREME:** Anti-corrosion treated anti-UV powder coated AISI 304 stainless steel (18/10)
- Screen-printed information plate

- Ref. 59228 - COLLEC - Manganese grey
- Ref. 54608 - COLLEC EXTREME - Manganese grey



Wall-mounted

For post-mounting

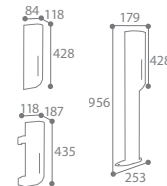

EXTREME version

Free-standing



## ARKEA CANIN

### GROUND FIXED BIN WITH DISPENSER FOR 200 BAGS

- Anti-corrosion treated and anti-UV powder-coated steel
- Discreet keyless dispenser locking system
- 4-point ground-anchoring system
- Easy to open by tilting the bucket forward
- Reduced opening to prevent the insertion of bulky objects
- Bag clamps to facilitate insertion and removal of the bag
- Screenprinted instructions
- Roll of 200 bags: flow regulator to facilitate single bag dispensing
- Optional batch of 200 rolls of bags (Ref. 55171) see p62

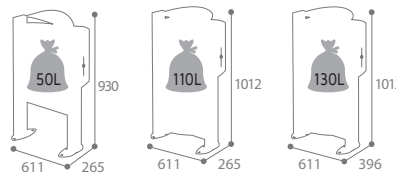
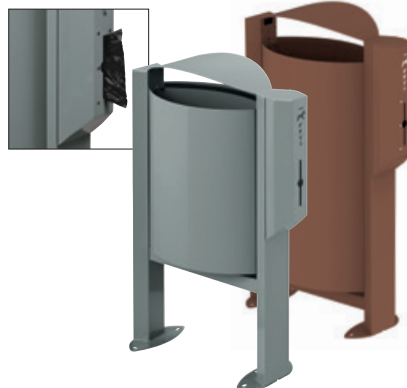

Colour	40L	60L	100L
■ Manganese grey	59160	59150	59145
■ Metal grey RAL 9006	59161	59151	59146
■ Anthracite grey RAL 7016	59163	59153	59148
■ Corten effect	59164	59154	59149

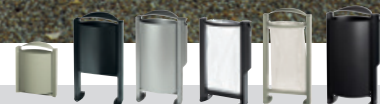

Discover all our ranges of ARKEA wall-mounted or ground fixed bins (p46)



# Kopa TOP SELLER



Easy to empty by removing the drawer and tipping the container.



## KOPA FREE-STANDING ASHTRAY/BIN

- Anti-corrosion treated steel body
- Anti-UV powder-coated aluminium profiles
- Triangular key-lock
- Bag held in place by Bag clamps
- Cigarette stub out grid made of AISI 304 stainless steel (18/10)
- 4 pads preventing corrosion of the base
- 4-point ground-anchoring system possible
- "Cigarette" sticker supplied

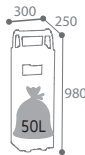

360L butts



720L butts

Colour	6L/30L	12L/60L
■ Cement grey RAL 7033	56445	56447
■ Metal grey RAL 9006	56431	56461
■ Manganese grey	56446	56448
■ Anthracite grey RAL 7016	56590	56591
■ Grey RAL 9006 /Manganese grey side	56161	56163



12L/60L - Manganese grey

6L/30L - Cement grey



2L

1L



## KOPA WALL-MOUNTED ASHTRAY

- Anti-corrosion treated and anti-UV powder-coated steel
- 4-point wall mounting system
- Triangular key-lock
- Emptied by removing
- "Cigarette" sticker supplied

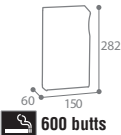

600 butts

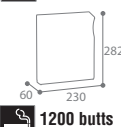

1200 butts

Colour	1L	2L
■ Corten effect	57672	57673
■ Cement grey RAL 7033	56425	56435
■ Metal grey RAL 9022	56428	56438
■ Manganese grey	56429	56439
■ Anthracite grey RAL 7016	56592	56593
■ Grey RAL 9022/Manganese grey side	56407	56258



## KOPA WALL-MOUNTED ASHTRAY/BIN 2L/15L

- Anti-corrosion treated and anti-UV powder-coated steel
- 4-point wall mounting system
- Unlock and unhook to empty
- Triangular key lock
- Post-mounted system possible
- "Cigarette" sticker supplied



Manganese grey

Grey 9022 / Manganese grey side

Colour	2L/15L
■ Corten effect	57669
■ Cement grey RAL 7033	56440
■ Metal grey RAL 9022	56443
■ Manganese grey	56444
■ Anthracite grey RAL 7016	56589
■ Grey RAL 9022/Manganese grey side	56153

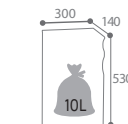

1200 butts

## ACCESSORIES

### CONCRETE IN POST FOR WALL MOUNTED ASHTRAY/BIN

- Anti-UV powder-coated steel
- Floor-anchoring
- Ref. 57693 - Manganese grey

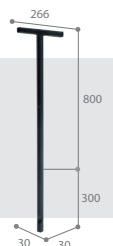

QUICK AND EASY EMPTYING  
SMALL FOOTPRINT  
PRACTICAL OPENING



## DISCO

### WALL-MOUNTED ASHTRAY

- 1.5 L and 0.5 L: AISI 304 powder-coated or brushed stainless steel (18/10)
- 2-point wall mounting system
- Emptied by unhooking and tipping
- Cigarette stub grid
- "Cigarette" sticker supplied



300 butts



900 butts

Colour	0,5L	1,5L
■ Brushed stainless steel	59005	-
■ Grey RAL 9022	58628	58638
■ Manganese grey	58645	58639
■ Anthracite grey RAL 7016	58608	58659
■ Corten effect	58600	58670

Discover our information plates (p35)



0,5L

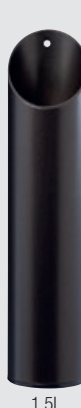

1,5L



Example of a sticker in place

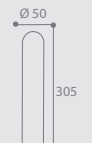

300 butts



## MEGOTUBE

### WALL-MOUNTED ASHTRAY

- Anti-UV powder-coated steel
- 1-point wall-mounting system
- For use in a covered area
- "Cigarette" sticker supplied

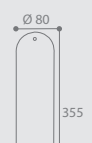

900 butts

- Ref. 58840 - Manganese grey - 0,5L
- Ref. 58839 - Manganese grey - 1,5L

# Arkea

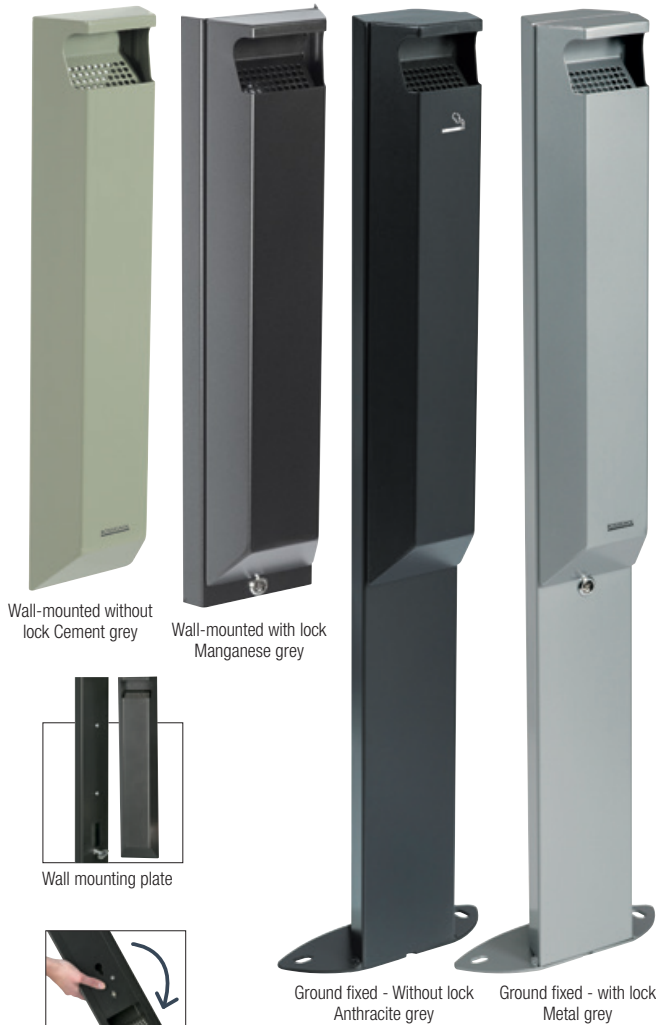

Wall-mounted without lock  
Cement grey

Wall-mounted with lock  
Manganese grey

Ground fixed - Without lock  
Anthracite grey

Ground fixed - with lock  
Metal grey

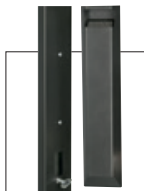

Wall mounting plate



Emptied by simply tipping



EXTREME VERSION

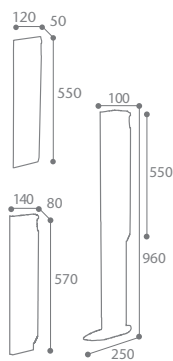

1800 butts

## ARKEA OR ARKEA EXTREME GROUND FIXED ASHTRAY- 3L

- Arkea:** Anti-corrosion treated and anti-UV powder-coated steel
- Arkea EXTREME:** Ashtray in AISI 304 18/10 stainless steel with anti-corrosion treatment + anti-UV powder coating.
- Stand made of hot dipped galvanised steel with anti-corrosion treatment + anti-UV powder coating.
- 3-point ground-anchoring system
- Triangular key lock (model with lock)
- "Cigarette" sticker supplied

Colour	WALL-MOUNTED		GROUND FIXED	
	without lock	with lock	without lock	with lock
<b>ARKEA</b>				
■ Cement grey RAL 7033	56510	56505	56520	56515
■ Metal grey RAL 9006	56513	56508	56523	56518
■ Manganese grey	56514	56509	56524	56519
■ Anthracite grey RAL 7016	56146	56145	56148	56147
<b>ARKEA EXTREME</b>				
■ Manganese grey	54599	54598	54600	54601

## COLLEC POST MOUNTED SIGNAGE PLATE "CIGARETTE" PICTO

- COLLEC:** Anti-corrosion treated and anti-UV powder-coated steel
- COLLEC EXTREME:** Anti-corrosion treated anti-UV powder coated AISI 304 stainless steel 18/10
- Screen-printed information plate
- Defines smoking area
- Manganese grey

- Ref. 56056 - COLLEC
- Ref. 55012 - COLLEC EXTREME



300  
408  
36



**Ideal final touch for your smoking areas and to reduce the quantity of cigarette butts on the ground.**



Simply remove to empty



1800 butts

## ARKEA POST MOUNTED ASHTRAY - 3L

- Anti-corrosion treated and anti-UV powder-coated steel
- Can be adapted to existing posts with a Ø of 50 mm (not supplied)
- Post-mounted with fixing clamps supplied
- "Cigarette" sticker supplied

Colour	Post-mounted without lock
■ Cement grey RAL 7033	56140
■ Metal grey RAL 9006	56143
■ Manganese grey	56144
■ Manganese grey EXTREME	54602
■ Anthracite grey RAL 7016	56141

Discover all our 1, 2 and 3 bin posts with a diameter of 50 mm (p30)

# Arkea Vote

**A fun way to encourage smokers to dispose of their cigarette butts appropriately**



Stainless steel cigarette stub plate

## ARKEA VOTE

### BALLOT ASHTRAY - 2X3L

- Anti-corrosion treated and anti-UV powder-coated steel
- Cigarette burn-resistant 4 mm tempered glass pane
- Set of 4 stickers included (French text)
- Post-mounted system: Mounting brackets supplied in galvanised steel
- Discreet keyless ashtray lock
- Emptied by simply tipping

- Ref. 59250 - Manganese Grey - Wall-mounted
- Ref. 59260 - Manganese Grey - Post-mounted



Discover our posts (p34)

\* Subject to compliance with installation and maintenance guidelines.



# Koa



Metal grey



Anthracite grey



Easy removal



Emptied by simply tipping



### MODIFICATION

## KOA WALL MOUNTED ASHTRAY - 2L

- Anti-corrosion treated and anti-UV powder-coated steel
- 4-point wall-mounting system
- Triangular key lock
- "Cigarette" sticker supplied

1200 butts

- Ref. 56458 - Metal grey RAL 9006
- Ref. 56459 - Manganese grey
- Ref. 56597 - Anthracite grey RAL 7016



In France, 30 billion cigarette butts thrown on the ground



It takes 10 to 12 years for a cigarette butt to breakdown, and just one of them is enough to pollute 500 litres of water.

# STOP cigarette butts!

Act now to keep shared spaces clean

Think about equipping your public spaces with our ashtrays.

Source: INERIS

## COLLEC WALL MOUNTED SIGNAGE PLATE "CIGARETTE" PICTO

- COLLEC** Anti-corrosion treated and anti-UV powder-coated steel
- COLLEC EXTREME** Anti-corrosion treated anti-UV powder coated AISI 304 stainless steel 18/10
- Screenprinted signage
- Defines smoking areas

- Ref. 56053 - COLLEC
- Ref. 55000 - COLLEC EXTREME



See the anti-smoking law (p110)



### MODIFICATION

## KOA GROUND FIXED ASHTRAY - 2.5L

- Anti-corrosion treated and anti-UV powder-coated steel
- 2-point ground-anchoring system
- Unhook and tilt to empty
- Triangular key lock
- "Cigarette" sticker supplied

1300 butts

- Ref. 56468 - Metal grey RAL 9006
- Ref. 56469 - Manganese grey
- Ref. 56598 - Anthracite grey RAL 7016



Easy removal  
Emptied by simply tipping



Manganese grey



Built-in inner bucket



Ref. Metal grey

### ACCESSORIES



**KOA BALLAST FOR FREE-STANDING ASHTRAY 2.5L**

- Anti-corrosion treated and anti-UV powder-coated steel
- Ballast disk 5 kg
- 2-point ashtray attachment system
- Enables different positioning of the ashtray

■ Ref. 56493 - Manganese grey



### MODIFICATION

## KOA GROUND FIXED OR WALL-MOUNTED ASHTRAY - 9L

- Anti-corrosion treated and anti-UV powder-coated steel
- 3 point ground fixing or 4 point wall fixing
- Triangular key lock
- "Cigarette" sticker supplied

5400 butts

- Ref. 56498 - Metal grey RAL 9006
- Ref. 56499 - Manganese grey
- Ref. 56599 - Anthracite grey RAL 7016

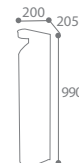



**NEW**



**HIGHLY RESISTANT AND VANDAL-PROOF  
SELF STABILISING**

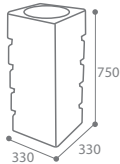

900 butts



**ARES  
FREE-STANDING 1.5L  
ASHTRAY**

- Concrete with white sandstone aspect finish
- Stainless steel 1,5L liner with anti-theft chain
- Delivered unmounted in 5 parts with central rod
- Bag of sand: 1 or 10 kg optional

Ref. 53338 - White sandstone aspect

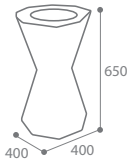

900 butts



**KEOPS  
FREE-STANDING OR FIXED  
ASHTRAY 1.5L**

- Concrete with white sandstone aspect finish
- Stainless steel 1,5L liner with anti-theft chain
- Bag of sand: 1 or 10 kg optional

Ref. 53339 - White sandstone aspect

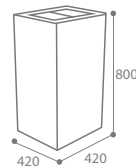

5400 butts



Large capacity

**OLYMPE  
FREE-STANDING OR FIXED 9L  
CONCRETE ASHTRAY**

- Concrete with exposed aggregate finish
- Stainless steel ashtray with large handle
- Bag of sand: 10 kg optional

Ref. 53341 - Aggregate finish

Discover the Olympe concrete bin (p 43)

Integrated water drainage hole

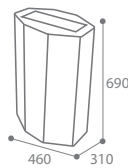

1200 butts



**CYCLADE  
FREE-STANDING OR FIXED  
ASHTRAY 2L**

- Concrete with white sandstone aspect finish
- Bag of sand: 1 or 10 kg optional

Ref. 53340 - White sandstone aspect

**CONSUMABLES**

**KIPSO  
BAG OF SAND**

- Fine sand to be changed once a week
- Neutralises tobacco odours

Ref. 59640 - 1 kg

Ref. 59704 - 10 kg





# Urban Furniture Ashtray

FOR BREAK AREAS  
AND UNDER COVER  
INSTALLATIONS



Brushed stainless steel

Manganese grey



## KALIPSO

### FREE-STANDING SAND ASHTRAY - 0.15L

- Anti-UV powder-coated steel or AISI 304 brushed stainless steel (18/10)
- Cigarette butt removal grid
- 1 Kg bag of sand supplied
- "Cigarette" sticker supplied

90 butts

- Ref. 59690 - Manganese grey
- Ref. 59693 - Brushed stainless steel



## KIPSO

### FREE-STANDING ASHTRAY/BIN - 0.25L/17.5L

- Anti-UV powder-coated steel or brushed stainless steel
- Black plastic base

150 butts

### SAND ASHTRAY/BIN

- Sand ashtray (anti-odour) + cigarette butt removal grid
- Bag of sand of 1 Kg supplied

■ Ref. 58958 - Brushed stainless steel

### SELF EXTINGUISHING ASHTRAY/BIN

- Self-extinguishing ashtray head (avoids the propagation of cigarette smoke)

- Ref. 58945 - Manganese grey
- Ref. 58948 - Brushed stainless steel



Removable sand ashtray with gripping handle

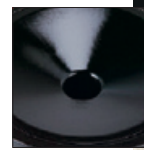

Removable extinguisher head



Sand ashtray  
Brushed stainless steel



self-extinguishing head  
Manganese grey



Brushed stainless steel self-extinguishing ashtray

TRY A LITTLE COLOUR! **100% customisable** CUSTOMISATION AVAILABLE SUBJECT TO

## CONSUMABLES

### KIPSO BAG OF SAND

- Fine sand to be changed once a week
- Neutralises tobacco odours

Ref. 59640 - 1 kg

Ref. 59704 - 10 kg



AISI 304 stainless steel (18/10) cigarette stub grid held by a chain

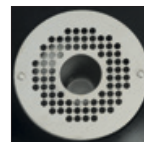

## CVVOMAX "GREEN"

### BIN WITH FLIP LID AND CIGARETTE STUB GRID - 52L

- Recycled polyethylene
- Automatic close with internal lever and spring to block the flap open
- Bag held in place by "Bag clamps"

■ Ref. 57428 - Black

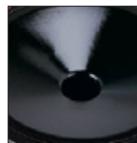
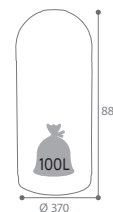

Removable self-extinguishing lid

Self-extinguishing ashtray + bin



Removable lid



Removable ashtray/bin



### FREE-STANDING ASHTRAY/BIN - 0.15L/12.5L

- Anti-UV powder-coated steel
- Black plastic base

90 butts

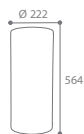

Colour	Self Extinguishing	Removable lid
■ Manganese grey	59775	59769

## ACCESSORIES

**COLLEC CIGARETTE STUB-OUT GRID**

- AISI 304 stainless steel (18/10)
- Installed on a post-mounted bag holder
- Clear picto instruction
- Facilitates the stubbing out of cigarettes

■ Ref. 57168 - Stainless steel

**COMPOSITION**

57841 + 58216 + 57168



# Indoor



Indoor

Desk bin

# Papea ULTRA ROBUST

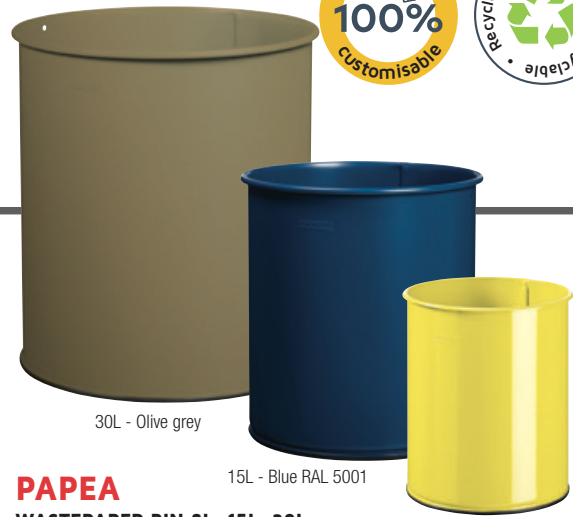

30L - Olive grey

15L - Blue RAL 5001

8L - Sulphur Yellow

## PAPEA

### WASTEPAPER BIN 8L, 15L, 30L

- Anti-UV powder coated steel sides and galvanised steel base
- Rubber rim on the base protecting against cleaning products and avoiding scratching the ground

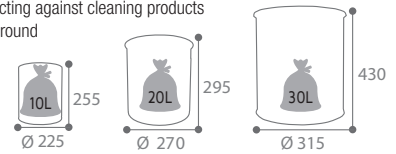

Colour	8L	15L	30L
□ Traffic white RAL 9016	59781	59580	59802
■ Manganese grey	59791	59583	58999
■ Grey RAL 9022	59804	59805	59803
■ Sulphur yellow RAL 1016	59845	59827	59850
■ Blue RAL 5001 smooth matt	59710	59750	59800
■ Olive grey RAL 7002 textured	59711	59751	59801
■ Stainless steel	59785	59592	-

TRY A LITTLE COLOUR! CUSTOMISABLE SUBJECT TO ESTIMATE - DISCOVER OUR STANDARD SHADES P.8



# Neo



## SELF EXTINGUISHING BIN



**Self-extinguishing principle**  
(See p79)

## NEO

### SELF EXTINGUISHING BIN

- Anti-UV powder coated steel sides and galvanised steel base
- Self-Extinguishing lid: prevents the combustion of litter and stops fire from spreading
- Approval of Neo bins by an independent body authorised by CNPP\* see p110

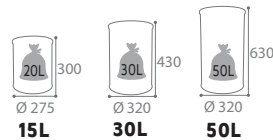

Colour	15L	30L	50L
■ Ultramarine RAL 5002	52155	52156	52157
■ Traffic red RAL 3020	52161	52162	52163
■ Colza yellow RAL 1021	52277	52278	52207
■ Light grey RAL 9022	52815	52816	52817
□ Traffic white RAL 9016	52140	52141	52142
■ Manganese grey	52810	52811	52812



\*National Centre for Prevention and Protection - Trials carried out without a bag

Discover our 90 L/110 L large volume collectors (p79)



# Cuba

PRACTICAL, AESTHETIC AND DISCREET ON THE DESK



CUSTOMISE  
WITH YOUR LOGO



**NEW**

## CUBA

### DESK TOP BIN - 1 L

- Anti-UV powder-coated steel
- 2 noise damping pads
- Use and empty by lifting the lid - Optional consumables (Ref. 55175)



EASY TO CLEAN  
NO VISUALISATION OF WASTE

### CONSUMABLES

#### CUBA GREEN

##### BATCH OF 50 PAPER BAGS

- Brown paper 50 gr
- PEFC certified (guarantee of sustainable forest management - see p108)
- Ref. 55175 - Brown



- Ref. 55730 - Traffic white RAL 9016
- Ref. 55731 - Manganese grey

- Ref. 54017 - Olive grey 7002 textured matt
- Ref. 54016 - Green blue 5001 smooth matt

Complete the waste sorting stream with our CUBATRI offer (p10-13)



## PEPS

### WASTEPAPER BIN 40L BATCH OF 4 BINS

- Polypropylene
- Smooth walls
- Gripping edge

- Ref. 59484 - Black - Per batch of 4

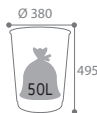

X4



LID WITH SLIDING FLAP



## OKTOP

### SLIDING LID BIN - 50L

- Polypropylene body
- Emptied by removing the head

- Ref. 59838 - Light grey/Dark grey



## CAP GREEN

### WASTEPAPER BIN 16L BATCH OF 20 BINS

- Recycled and recyclable polypropylene
- Light thanks to its "baguette" perforated wall
- Gripping edge and full bottom

- Ref. 59490 - Black - Batch of 20



X20





Indoor

Reception/Common area bin



# Paceo

DEMARCATÉ YOUR RECEPTION AREAS

## WALL MOUNTED

### PACEO

#### WALL MOUNTED RETRACTABLE BELT BARRIERS

- Powder-coated steel
- **Retractable and lockable strap (3 m)**
- 4-point wall mounting system
- Wall bracket provided

Colour	Wall-mounted
■ Manganese grey - black strap	51756
■ Smooth green blue RAL 5001 - black strap	51758
■ Manganese grey - red strap	51890
■ Manganese grey - blue strap	51891
■ Manganese grey - black/yellow strap	51892
■ Manganese grey - red/white strap	51893



100% CUSTOMISABLE  
(STRAP MARKING  
ON REQUEST)

### PACEO

#### PACK OF 2 RETRACTABLE BELT BARRIERS ON A PEDESTAL

- Powder-coated steel or stainless steel
- **Retractable and lockable strap (3 m)**: installation on another post or on a supplied wall bracket
- Ø tube: 63.5 mm
- 6 rubber pads under the plate

Colour	Pedestal (set of 2)
■ Manganese grey - Black strap	51741
■ Stainless steel - Black strap	51740
■ Blue RAL 5001 smooth mat - Black strap	51759
■ Manganese grey - Red strap	51885
■ Manganese grey - Blue strap	51886
■ Manganese grey - Black/yellow strap	51887
■ Manganese grey - Red/white strap	51888



INSTALLATION  
IN A COVERED AREA



#### ACCESSORIES

##### A4 SIGNAGE PANEL FOR BELT BARRIER PEDESTAL

- Chromium-plated steel
- Plastic mounting bracket
- Vertical rotary information panel
- Double plexiglass plate for A4 format documents

■ Ref. 51748 - Chrome



Landscape

Portrait

# Indik



Magnetic pouch

### INDIK

#### FREE STANDING INFORMATION PANEL - A4

- Anti-UV powder-coated steel
- 4 adjustable feet
- Delivered assembled
- Supplied with magnetic pouch

Colour	Panel	
	Landscape	Portrait
□ Traffic white RAL 9016	55008	55006
■ Manganese grey	55009	55007



# Collectik

IDEAL FOR CAR PARKS, SHOPS, ETC.

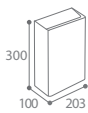

## COLLECTIK TICKET COLLECTOR - 5L

Simple emptying through magnetic hatch

- Anti-UV powder-coated steel
- Stainless steel hinge
- Reduced openings to prevent the introduction of bulky objects
- Easy emptying thanks to a magnetic hatch located under the product

■ Ref. 51336 - Manganese grey

# Salsa

FINGERPRINT RESISTANT



Opening/closing in one movement

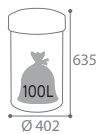

## SALSA ROUND SWIVEL LID BIN 60L

- Stainless steel body and lid (fingerprint resistant)
- Swivel lid with adjustable stabilising counterweight
- Lid thickness: 0.5 mm / Body: 0.4 mm
- 2 integrated gripping handles on the body
- Base: Polypropylene plastic protecting from cleaning products

■ Ref. 51880 - Stainless steel

### ACCESSORIES

#### 40 L PLASTIC BUCKET FOR SALSA BIN

- Polypropylene
- Metal handle

■ Ref. 51881 - Black



# Kipso

KEEP YOUR UMBRELLAS TIDY!



## KIPSO UMBRELLA STAND - 28L

- Anti-UV powder-coated steel or brushed stainless steel
- Black plastic plate protecting against cleaning products and avoiding ground scratches.

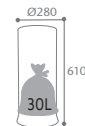

### Colour

- Traffic white RAL 9016
- Manganese grey
- Grey RAL 9022
- Stainless steel
- Sulphur yellow RAL 1016
- Matt olive grey texture RAL 7002
- Blue smooth matt RAL 5001

Full Body	Perforated body
58536	59101
58969	59105
58537	59103
58979	59100
58732	59104
59131	59114
59132	59115



Full body

Perforated body





Indoor

Reception/Common area bin



# Handtouch Sensitive



Push opening mechanism



## HANDTOUCH BIN WITH PUSH OPENING LID 45L

- Anti-UV powder-coated steel or stainless steel body
- ABS cover
- Manual opening system
- Removable plastic inner bucket with metal handle
- Rubber seal base

Colour	45L
<input type="checkbox"/> Traffic white RAL 9016	93580
<input checked="" type="checkbox"/> Manganese grey	93581
<input checked="" type="checkbox"/> Grey RAL 9022	93582
<input checked="" type="checkbox"/> Stainless steel	93590
<input checked="" type="checkbox"/> Sulphur yellow RAL 1016	93588
<input checked="" type="checkbox"/> Blue smooth matt RAL 5001	93593
<input checked="" type="checkbox"/> Matt olive grey texture RAL 7002	93594



Automatic opening



## SENSITIVE BIN WITH AUTOMATIC OPENING LID 45L

- Anti-UV powder-coated steel or stainless steel body
- ABS cover
- Fast and silent infra-red automatic opening system
- Prolonged opening possible with contactless open & close button
- Removable plastic inner bucket with metal handle
- Rubber seal base
- 4 LR6 batteries not included
- HACCP compliant

Colour	45L
<input type="checkbox"/> Traffic white RAL 9016	93560
<input checked="" type="checkbox"/> Manganese grey	93561
<input checked="" type="checkbox"/> Grey RAL 9022	93562
<input checked="" type="checkbox"/> Stainless steel	93570
<input checked="" type="checkbox"/> Sulphur yellow RAL 1016	93568
<input checked="" type="checkbox"/> Blue smooth matt RAL 5001	93573
<input checked="" type="checkbox"/> Matt olive grey texture RAL 7002	93574

# Push THE "MUST HAVE"



## PUSH PUSH LID BIN 45L

- Anti-UV powder-coated steel or stainless steel
- Bag held in place by "Bag clamps"
- Push lid in stainless steel with automatic return

Colour	45L
<input type="checkbox"/> Traffic white RAL 9016	57467
<input checked="" type="checkbox"/> Manganese grey	57469
<input checked="" type="checkbox"/> Grey RAL 9022	59793
<input checked="" type="checkbox"/> Stainless steel	57468
<input checked="" type="checkbox"/> Sulphur yellow RAL 1016	57423
<input checked="" type="checkbox"/> Blue smooth matt RAL 5001	57478
<input checked="" type="checkbox"/> Matt olive grey texture RAL 7002	57479

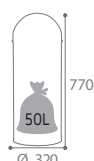

Olive grey



Sulphur yellow



Bag held in place by "Bag clamps"



Grey





# Multigob IDEAL IN BREAK AREAS



## MULTIGOB CUP COLLECTOR

- Polyethylene head
- Receptacle for cups (maximum diameter 70 mm)
- Partition between the miscellaneous waste and the cups
- Bag clamps to hold the bag in place



Bag clamps to hold the bag in place



Integrated signage

Grey

Traffic white

### MULTIGOB "GREEN"

- "All plastic" version
- Body made of **recycled polyethylene**
- Light and handy

### MULTIGOB

- "Metal body" version
- Powder-coated steel body with polypropylene rim

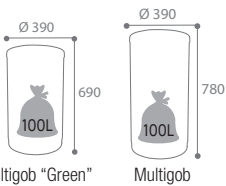

Multigob "Green"

Multigob



Colour	Up to 1600 cups	Up to 800 cups + 25L bin
■ Black - Plastic tub + lid	57342	57403
■ Manganese grey - Metal tub	56210	56213
■ Grey RAL 9022 - Metal tub	56211	56214
□ Traffic white RAL 9016 - Metal tub	56212	56215



# Cyvomax



## CYVOMAX "GREEN"

### PUSH LID BIN 52L

- **Recycled** polyethylene
- Automatic close with internal lever and spring to block the flap open
- Bag held in place by "Bag clamps"

■ Ref. 58033 - Black

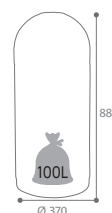



Indoor

Food waste bin



# Gobtout

IDEAL FOR SANDWICH SHOPS, CAFÉS, ETC.

VANDAL-PROOF

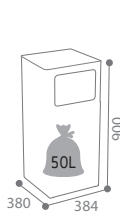

Galvanised steel bucket



## GOBTOUT

### SNACK BAR BIN - 40L

- Anti-UV powder-coated steel
- Stainless steel hinge
- Flat surface on top of the bin for depositing trays
- 40 L galvanised steel bucket with handle supplied
- Easy insertion of waste thanks to 3 large openings
- Plastic feet avoiding contact with the ground
- Vandal-proof: door locking by key lock and 4-point floor-anchoring possible

■ Ref. 59854 - Manganese grey



ENTRUST US WITH YOUR TAILOR-MADE PROJECTS

DISCOVER THE ALITRI WASTE SORTING UNITS FOR THE FOODSERVICE INDUSTRY - SEE P20-21



# Collecroule



## COLLECROULE

### MOBILE BAG HOLDER WITH PEDAL 50L AND 110L

- Anti-UV powder-coated steel or stainless steel
- Wide pedal
- Bag held by an elastic strap
- HACCP compliant

#### 50L

■ Ref. 57371 - Grey RAL 9022\*

#### 110L

- Ref. 57330 - Grey RAL 9022
- Ref. 57370 - Traffic white RAL 9016
- Ref. 56501 - Stainless steel

Discover our mobile bag holders with coloured lid (p.25)



Carrying handle for improved handling

White signalisation 110L

Smooth wheels

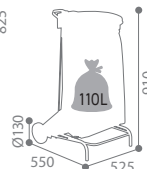
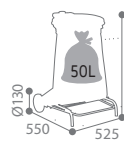

## ACCESSORIES

### CONNECTING PLATE FOR SORTING STATION

- Anti-UV powder-coated steel
- 4 PVC clamps screwed to the plate
- Ideal for creating recycling stations
- Facilitates attaching COLLECROULE or TUBAG sack holder together

■ Ref. 57223 - Manganese grey

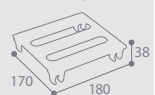



# Mobily

3 SIZES



Hinged back lid flush with the tub



## MOBILY

MOBILE PEDAL BIN  
60L, 80L AND 120L

- High-density polyethylene (HDPE)
- Smooth wheels
- Carrying handle
- Set of stickers (Ref. 50297) optional
- **HACCP compliant**

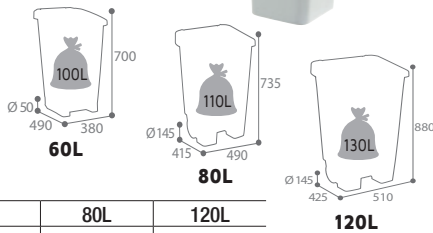

Colour	60L	80L	120L
<input type="checkbox"/> White	59837	59185	59200

Discover our new Mobily Green recycled high-density polyethylene bins (p24)



# Boogy FUNCTIONAL

**CORROSION-RESISTANT STAINLESS STEEL LINKAGE MECHANISM**

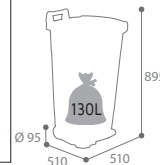
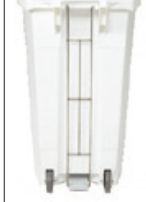

## BOOGY

MOBILE PEDAL BIN - 90L

- Polyethylene
- Linkage mechanism in AISI 304 stainless steel (18/10)
- Wide pedal and built-in handle on front
- Carrying handle
- Optional sticker set (Ref. 50297)
- **HACCP compliant**

Ref. 56700 - White

Discover our set of waste sorting stickers Ref. 50297 (p24)



# Utilo 4 SIZES



Grip handle



30L



50L

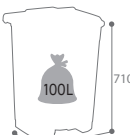

80L

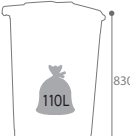

100L

Wide pedal

## UTILO

PEDAL BIN 30L, 50L, 80L AND 100L

- Polypropylene
- Wide pedal on the front
- Plastic pedal mechanism
- Resistant and easy to clean
- Set of stickers (Ref. 50297) optional
- **HACCP compliant**

- Ref. 54020 - White - 30L
- Ref. 54040 - White - 50L
- Ref. 54060 - White - 80L
- Ref. 54080 - White - 100L

Discover our coloured lid collectors (p30)



# Pratik



ASSEMBLE YOUR COLLECTOR IN 3 STEPS



## PRATIK

FOOD COLLECTOR - 100L

- High-density polyethylene (-50° to 80/120°C)
- **Suitable for food contact**

Colour	Body	Lid
<input type="checkbox"/> White	56285	56290

Discover our Colour collectors PRATIK (P.25)

## ACCESSORIES

### DOLLY ON WHEELS

- Compatible with the PRATIK 100 L bins
- 5 wheels
- Integrated brake

Ref. 57633 - Black



Improved hold of the tub to the dolly



Indoor

Industry waste bins



# Tubag HIGHLY MANOEUVRABLE



Free-standing

On castors



## TUBAG

### TUBULAR BAG HOLDER - 110L

- Anti-UV powder-coated steel
- Ø tube: 18 mm
- Bag held in place by tension

Colour	Free-standing	On castors
■ Ultramarine RAL 5002	57533	57529
■ Colza yellow RAL 1021	57534	57530
■ Moss green RAL 6005	57535	57531
■ Manganese grey	57536	57532
□ Traffic white RAL 9016	57541	57540

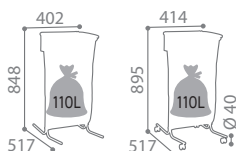

### ACCESSORIES



### TUBAG / HERMIX

#### WASTE SORTING INFORMATION PLATE

- Anti-UV powder-coated steel
- Screen-printed information plate
- Makes it possible to identify the type of waste

#### Colour

■ Ultramarine RAL 5002 - Papier / Paper	56012
■ Moss green RAL 6005 - Verre / Glass	56014
■ Colza yellow RAL 1021 - Emballages / Packaging	56013
■ Manganese grey - Autres déchets / Other waste	56015

### MODIFICATION



Easy to install on the bag holder



### CONNECTING PLATE FOR SORTING STATION

- Anti-UV powder-coated steel
- 4 PVC clamps screwed to the plate
- Ideal for making sorting stations
- Enables the attachment of 2 TUBAG or COLLECROLE bag holders

■ Ref. 57223 - Manganese grey



# Tubeo



## TUBO

### WALL-MOUNTED BIN - 80L

- Anti-corrosion treated and anti-UV powder-coated steel
- Bag held by "Bag clamps"
- Optional wall mounting plate
- Post mounting possible with clamps (supplied) and post not supplied (see p34)

- Ref. 58146 - Manganese grey
- Ref. 58147 - Manganese grey/Colza yellow RAL 1021
- Ref. 58148 - Manganese grey/Moss green RAL 6005
- Ref. 58149 - Manganese grey/Ultramarine RAL 5002
- Ref. 58144 - Manganese grey/Traffic red RAL 3020

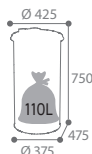

### ACCESSORIES

### COLLEC

#### WALL-MOUNTING PLATE

- Makes it easier to mount the bin on the wall (2 plates necessary for TUBO)

■ Ref. 57024 - Manganese grey

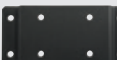

#### 3-BIN FREE-STANDING SUPPORTING POST + CLAMP KIT

- Anti-corrosion treated and anti-UV powder-coated steel

■ Ref. 58819+58837 Manganese grey



Discover all our posts (p34)



# Neo



**SELF EXTINGUISHING BIN**



**Technical assessment carried out by the CNPP\*:**  
product complies with the technical specification.  
CNPP: a certification body in the fields of fire prevention and protection drawing on the expertise of its laboratories and inspection and audit services.



**Self-extinguishing principle**

## NEO

### SELF EXTINGUISHING BIN

- Anti-UV powder coated steel sides, galvanised steel base
- Self extinguishing lid: prevents the combustion of litter and stops fire from spreading
- **CNPP\* fireproof certification** (if body and lid combined)

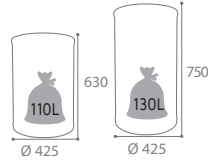

Colour	90L	110L
■ Ultramarine RAL 5002	52158	52159
■ Traffic red RAL 3020	52164	52165
■ Colza yellow RAL 1021	52209	52205
■ Grey RAL 9022	52818	52819
□ Traffic white RAL 9016	52143	52144
■ Manganese grey	52813	52814

### ACCESSORIES

#### BAG CLAMPS 90L AND 110L

- Anti-UV powder coated steel
- Fixings supplied

■ Ref. 52211 - Light grey RAL 9022



Discover our small volume collectors 15L/30L/50L (p70)

\*National Centre for Prevention and Protection - Trials carried out without a bag

# Barella

CONVENIENT TO USE AND EMPTY

## ASSEMBLE YOUR BARELLA COLLECTOR IN 3 STEPS

### 1 the tub (choice of 2 sizes)

#### BARELLA

- Polypropylene
- 2 built-in handles
- Colour grey



**TUB - 80L**  
■ Ref. 56556



**TUB - 120L**  
■ Ref. 56557

### 2 the lid (choice of 3)

- Snaps onto the tub



**FLAT LID**  
■ Ref. 56540 - 80L  
■ Ref. 56541 - 120L



**FUNNEL LID**  
■ Ref. 56544 - 80L  
■ Ref. 56545 - 120L



**PUSH LID**  
■ Ref. 56542 - 80L  
■ Ref. 56543 - 120L

### 3 dolly on wheels (to match tub size)



- Facilitates maneuverability of the tub
- Attaches to the tub by quarter turn

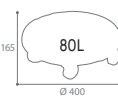

**DOLLY - 80L**  
■ Ref. 56280 - 80L



**DOLLY - 120L**  
■ Ref. 56281 - 120L

### EXAMPLES OF COMPOSITION



56556 + 56540

56556 + 56544

56556 + 56542

56557 + 56545 + 56281





Indoor

Health equipment



# Collecroule VERSATILE



Removable facade for easy bag removal

## COLLECROULE CARENE

### MOBILE PEDAL BIN

- Anti-UV powder-coated steel or stainless steel
- Wide pedal
- 2 wheels to the front
- Sticker (Ref. 50292) optional
- **HACCP compliant**

Colour	70L	110L
<input type="checkbox"/> Traffic white RAL 9016	57251	57250
<input type="checkbox"/> Stainless steel	57256	57255

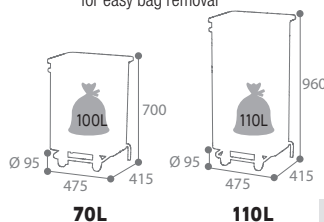

110L – Stainless steel

70L – Traffic white + sticker



Discover our "Throw away your rubbish" sticker Ref. 50292 (p13)



# Tubag



On wheels



Free-standing



## TUBAG

### TUBULAR BAG HOLDER - 110L

- Anti-UV powder-coated steel
- Ø tube: 18 mm
- Bag held in place by tension

Colour	Free-standing	On wheels
<input type="checkbox"/> Traffic white RAL 9016	57541	57540

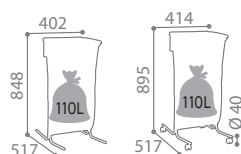

Discover our TUBAG Colour (P.78)



### ACCESSORIES

#### CONNECTING PLATE FOR SORTING STATION

- Anti-UV powder-coated steel
- 4 PVC clamps screwed to the plate
- Ideal for making sorting stations
- Enables the attachment of 2 TUBAG or COLLECROULE bag holders



■ Ref. 57223 - Manganese grey

# Hermix



Mobile thanks to its 2 castors

## HERMIX

### HERMETICALLY SEALED SACK HOLDER 50L AND 110L

- Stainless steel
- Stainless steel AISI 304 (18/10) suitable for wet environments (stainless steel tubes and screws)
- Sack holder with hermetic rubber seal
- Wide pedal
- **HACCP compliant**

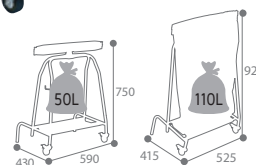

Colour	50L	110L
<input type="checkbox"/> Stainless steel	59477	59480
<input type="checkbox"/> Stainless steel AISI 304 (18/10)	-	59479

Discover our signage plates for TUBAG and HERMIX (p 78)



# Clinix

## CONSUMABLES

### CLINIX

#### FIRST AID EQUIPMENT KIT

- Consumable for the CLINIX wall-mounted first aid case (Ref. 99717) and for the CLINIX medicine cabinets (Ref. 11649 and 50201)



#### Composition of the equipment kit:

- 1 compression bandage 10 x 12 cm
- 1 safety pin
- 1 stretch elastic mesh band 3 m x 5 cm
- 1 stretch elastic mesh band 3 m x 7 cm
- 4 bactericidal wipes
- 4 drying wipes (eosin equivalent)
- 4 calendula soothing wipes
- 1 white fabric plaster 5 m x 2cm
- 1 pair of gloves
- 18 Urgo dressings 3 sizes
- 10 sterile compresses 20 x 20 cm
- 1 chemical breathalyser

Ref. 99715 - Consumables kit



#### Composition of the equipment kit:

- 1 insulating survival blanket (2.10 x 1.60 m)
- 1 imitation leather finger cap
- 1 compression bandage 10 x 12 cm
- 9 safety pins
- 1 stainless steel tweezers
- 1 stretch elastic mesh band 3 m x 5cm
- 1 stretch elastic mesh band 3 m x 7cm
- 4 bactericidal wipes
- 4 drying wipes (eosin equivalent)
- 4 calendula soothing wipes
- 1 pair of stainless steel scissors 14 cm
- 1 white fabric plaster 5 m x 2cm
- 1 pair of gloves
- 18 Urgo dressings 3 sizes
- 10 sterile compresses 20 x 20 cm
- 1 chemical breathalyser

Ref. 99712 - First aid kit

\*Sold without consumables



1-door cabinet

2-door cabinet



### CLINIX\*

#### MEDICINE CABINET - 1 AND 2 DOOR

- Anti-UV powder-coated steel
- Height-adjustable transparent plastic shelves
- Transparent plastic storage boxes and shelves in the doors
- Key lock

Ref. 11649 - Traffic white RAL 9016 - 1 door

Ref. 50201 - Traffic white RAL 9016 - 2 door



### CLINIX\*

#### FIRST AID BOX WITH WALL MOUNTING PLATE

- Polypropylene

Ref. 99717 - White



Can be installed in a vehicle with its wall-mounting

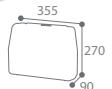

## LEGISLATION



### FIRST AID

**Decree no. 2008-244 of 7 March 2008** concerning the Labour Code contains three basic articles: Article R4224-14 of the Labour Code lays down that "workplaces must be equipped with first-aid equipment that corresponds to the nature of the risks and that is easily accessible". The employer must take the necessary measures to ensure the safety and protect the physical and mental health of workers within its premises.



Indoor

Health equipment

## Clinabox



Easy front opening

### CLINABOX

#### TISSUE/GLOVE/AIRNET BOX HOLDER

- Stainless steel
- 2-point wall-mounting system possible

■ Ref. 56130 - Stainless steel

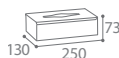

## Sanipla



Easy side opening

### SANIPLA

#### TISSUE/GLOVE/AIRNET BOX HOLDER

- White plastic
- 2-point wall-mounting system possible

□ Ref. 51340 - White plastic



## Clinix FIRST AID EQUIPMENT



### CLINIX

#### DEFIBRILLATOR BOX\*

- Anti-UV powder-coated steel
- Front opening facilitating access
- Secured closed with quick release cable tie (10 supplied with the product)

■ Ref. 50410 - Mint green RAL 6029

#### CONSUMABLES

##### PACK OF 10 QUICK RELEASE CABLE TIES

- Cable diameter Ø2.2mm
- Total length 279mm
- Usable length 240mm
- Tensile strength 5 kg
- Progressive tightening notches
- 50399 Pack of 10 cable ties

■ Ref. 50399 - Pack of 10 cable ties

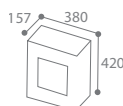

\*sold without defibrillator



# Hygiene



# Blanka • Stella • Manga • Axios

□ White RAL 9016  
(UV-resistant powder-coated steel)

■ Metal Grey RAL 9006  
(UV-resistant powder-coated steel)

■ Manganese grey  
(UV-resistant powder-coated steel)

□ Brushed stainless steel F17



BLANKA 400M

## TOILET PAPER DISPENSER 200 M AND 400 M

- Key lock
- Core: Ø 50 mm
- Chiselled blades for easy cutting of the paper on the left or right



## HAND TOWEL DISPENSER 400 SHEETS

- Key lock
- Capacity: up to 400 folded hand towel sheets (24 x 26 cm)
- Front opening and blocking of the cover in an open position: facilitates refilling
- Integrated plastic dispensing control system: ensures the hand towels are dispensed sheet by sheet



AXIOS



TWIN ROLL DISPENSER ON REQUEST

## TOILET PAPER DISPENSER 1 ROLL

- Takes 1 "domestic" type roll



STELLA

## TOILET PAPER DISPENSER 2 PACKETS/1 ROLL

- Key lock
- Takes 2 packs of "domestic" type folded toilet paper or 1 "domestic" type roll



MANGA



Key lock

## AXIOS

### SOAP DISPENSER - 1L

- AISI 304 brushed stainless steel (18/10)
- Push button with brass and plastic pump
- Plastic consumption indicator
- Filling from above
- Accepts all types of soap (except microbeads and hydroalcoholic gel)
- 3-point wall mounting system
- Screws supplied

■ Ref. 51397 - Stainless steel



Transparent tank / Non-drip pump

## SANEVA

### SOAP DISPENSER - 1.1 L

- White ABS with antistatic additive
- Key lock
- Manual dispenser triggered by pushing a button
- Consumable control window
- Compatible with disinfectant solutions such as hydroalcoholic gel (except for microbeads)

□ Ref. 52544 - White



### OPTIONAL



### TANK LID FOR SOAP DISPENSER

- Prevents gel evaporation
- Dim. : 115 x 50 x 5 mm

□ Ref. 52485



Range Colour	Toilet paper dispenser				Dispenser
	1 roll	2 packets 1 roll	200M	400M	Hand towels 400 sheets
<b>BLANKA</b> □ White RAL 9016	58101	58110	58574	58586	53045
<b>STELLA</b> ■ Metal grey RAL 9006	52653	52667	52666	52665	52652
<b>MANGA</b> ■ Manganese grey	58102	58114	58578	58579	53049
<b>AXIOS</b> □ Brushed stainless steel F17	52103	58111	52615	58590	53047

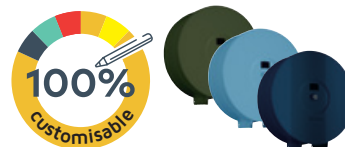

# Oleane WHITE ABS

- White ABS plastic
- Wide consumable control window
- Front opening: facilitating refilling and cleaning
- Key lock



## PAPER TOWEL DISPENSER - 400 SHEETS

- Capacity: up to 400 folded hand towel sheets (24 x 26 cm)
- Optional : Flow regulator to ensure sheet by sheet dispensing

□ Ref. 52530

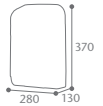

## TOILET PAPER DISPENSER

- Capacity: 2 packs of folded "domestic" type toilet paper or 1 "domestic" type roll

□ Ref. 52560 - 2 packs/1 reel



- Capacity: 6 packs of folded "domestic" type toilet paper or 1 "domestic" type roll
- Possibility to store an extra roll

□ Ref. 52561 - 6 packs 1 roll



## TOILET PAPER DISPENSER - 200M AND 400M

- Core: 45 mm
- Chiselled edges for easy cutting of the paper on the left or right
- Economical: the unrolling of the paper is slowed down by the shape of the plastic core

□ Ref. 52570 - 200M

□ Ref. 52580 - 400M

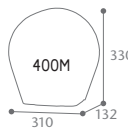
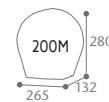

## CENTRAL FEED HAND TOWEL DISPENSER - 450 FORMAT

- Takes rolls of 450 format (max. Ø: 220 mm, max. height: 250 mm)

□ Ref. 52627

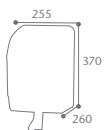

## CENTRAL FEED HAND TOWEL DISPENSER 150 FORMAT

- Takes rolls of 150 format (max. Ø: 120 mm, max. height: 250 mm)

□ Ref. 52621



## SOAP DISPENSER

- Takes all types of soap, including hydroalcoholic gel (except microbeads)
- Transparent tank/non-drip pump
- Removable lid for top filling

□ Ref. 52550 - 0.8 L - White/Transparent

□ Ref. 52548 - 1.5 L - White/Transparent



## ACCESSORIES

### PACK OF 5 FLOW REGULATORS

- EVA plastic
- Regulates the dispensing of the hand towels by dispensing sheet-by-sheet

□ Ref. 52529 - White

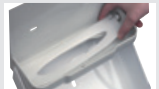

## SANITARY BAG DISPENSER

- Front opening: easy to grasp the bags
- Key lock

□ Ref. 52540 - White



## CONSUMABLES

### FEMINA

### BAGS FOR SANITARY WASTE

- Plastic sanitary waste bags
- 20 bags per refill (48 refills/mastercarton)
- Consumable for the OLEANE sanitary bag dispenser (Ref. 52540)

Ref. 51220 - Pack of 960 bags - White



## MODIFICATION

## MANUALLY OPERATED PRE-CUTTING MECHANISM

### AUTOCUT HAND TOWEL DISPENSER

- ABS plastic shell with "antistatic" additive
- Mechanical paper feeder
- Large consumable control window
- Takes rolls with a max. Ø of 190 mm and a max. height of 210 mm (mandrel Ø45 mm).
- Internal steel pre-cutting blade fully protected and without external access
- Quick and easy to refill
- Key lock

□ Ref. 52649 - White

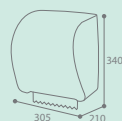

Discover our dispensers for feminine hygiene sanitary bags and bins (p.92-93)



# Hygiene Dispenser

## Lensea WHITE ABS PLASTIC

- White ABS dispenser with plastic wallplate
- Large consumable control window
- Key lock

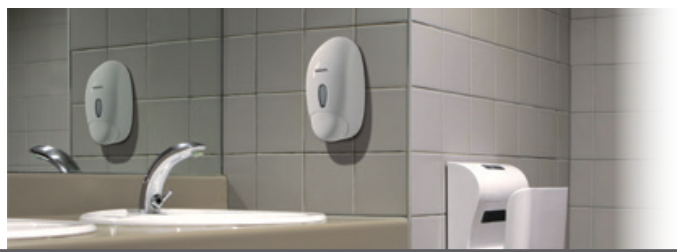

### TOILET PAPER DISPENSER 200 M AND 400 M

- Core: Ø40 (200 mm) or Ø50 (400 mm)

- Ref. 52718 - White - 200M
- Ref. 52719 - White - 400M

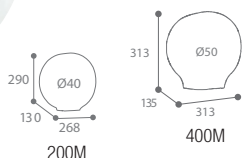

### HAND TOWEL DISPENSER 400 SHEETS

- Capacity: up to 400 folded hand towel sheets (24 x 26 cm)
- Front opening: facilitates refilling
- Integrated flow regulator

- Ref. 52673 - White

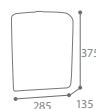

### SOAP DISPENSER - 1 L

- Removable inner tank in transparent plastic for top filling
- Dispensing system with non-drip valve
- Takes all types of soap, including hydroalcoholic gel (except microbeads)

- Ref. 52670 - White



## + ECONOMICAL: DISPENSING THE RIGHT AMOUNT OF SOAP OR DISINFECTANT GEL



**AUTOMATIC CONTACT-FREE**

### AUTOMATIC SOAP DISPENSER - 0.850 L

- White ABS plastic
- Automatic infra-red sensor distribution
- Key for locking the tank from above
- Flow Rate Adjustment: 0.5 ml to 2.5 ml
- Powered by 4 LR6 batteries (not supplied)
- Takes all types of soap, including hydroalcoholic gel (except microbeads)

- Ref. 51785 - White RAL 9016



Discover our automatic hand disinfection stations (p.90-915)

**ROSSIGNOL** PRO





IDEAL FOR SANITARY SPACES WITH QUALITY, FUNCTIONALITY AND DESIGN

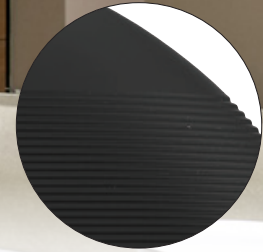

# Eclipse "Green"

## ECLIPSE "GREEN"

### - 100% recycled ABS

- Key lock
- Large consumable control window
- Anti-theft
- Front opening: facilitates refilling



### SOAP DISPENSER - 1L

- Manual dispenser triggered by pushing a button
- Anti-drip system
- Transparent removable reservoir
- Flow-rate: 1 ml with each press
- Accepts all types of soap, including hydroalcoholic gel (except microbeads)

■ Ref. 52004 - Matt black

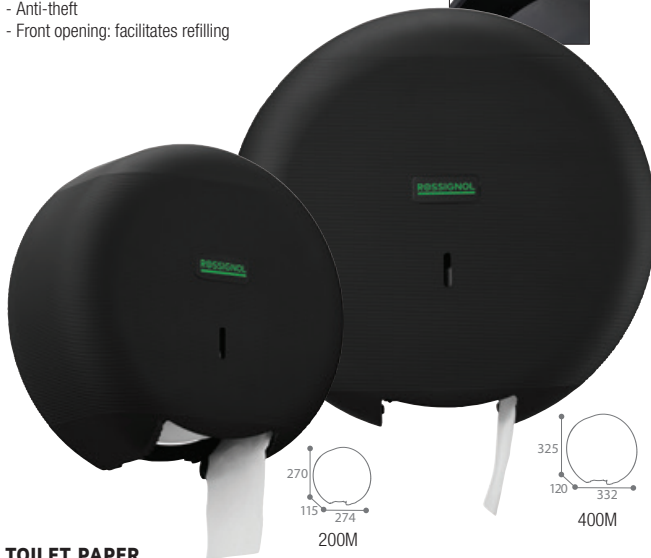

### TOILET PAPER DISPENSER - 200M AND 400M

- 200M: Core Ø 40 mm (Ø roll 208 mm max.)
- 400M: Core Ø 50 mm (Ø roll 270 mm max.)

■ Ref. 52000 - 200M - Matt black  
 ■ Ref. 52001 - 400M - Matt black

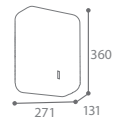

### HAND TOWEL DISPENSER 600 SHEETS

- Capacity: up to 600 folded hand towel sheets (24 x 26 cm)

■ Ref. 52002 - Matt black



### TOILET PAPIER DISPENSER - FRONT FEED - 200 M

- Roll diameter 208 mm max.
- Frontal sheet by sheet dispensing
- Consumable Dispensing Control System

■ Ref. 52005 - Matt black



Standard With flow regulator

### CENTRE FEED HAND TOWEL DISPENSER 450 FORMAT

- Capacity: rolls up to 450 formats (max. Ø 210mm x H210mm)
- Flow regulator (for Ref 52006)

■ Ref. 52003 - Standard - Matt black  
 ■ Ref. 52006 - With flow regulator - Matt black

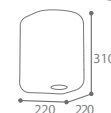



Hygiene

Dispenser

# Kosteas

TRANSLUCENT POLYCARBONATE WITH A CLEAN LINES

- Translucent polycarbonate
- Unbreakable: thickness 3 mm
- Visualisation of level as casing is translucent
- Easy to clean due to its rounded shape
- Key lock



## TOILET PAPER DISPENSER - 400 M

- Core: Ø 55 mm
- Economical: Mandril has an integrated brake to limit dispensing of paper

Ref. 51060

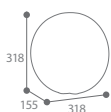

## UNBREAKABLE



## SOAP DISPENSER - 0.850 L

- Removable inner tank in transparent plastic for top filling
- Anti-drip valve distribution system
- Takes all types of soap, including hydroalcoholic gel (except microbeads)
- Flow: 1 ml with each press

Ref. 51061



## HAND TOWEL DISPENSER 600 SHEETS

- Capacity: up to 600 folded hand towel sheets (24 x 26 cm)

Ref. 51062

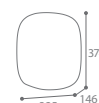

# Clara

- AISI 304 brushed or powder-coated stainless steel 18/10
- Key lock
- Consumable control window
- Front opening: facilitates refilling



## + RESISTANT



## TOILET PAPER DISPENSER - 200 M

- Core: Ø 45 mm (Ø roll 250 mm max.)



- Ref. 52669 - Brushed stainless steel
- Ref. 52725 - Manganese grey
- Ref. 52726 - White RAL 9016
- Ref. 52727 - Pastel blue RAL 5024



## SOAP DISPENSER - 1.1 L

- Manual dispenser triggered by pushing a button. Anti-drip pump
- Filling from above
- Flow-rate: 1.3 ml with each press
- Accepts all types of soap, including hydroalcoholic gel (except microbeads)

- Ref. 52545 - Brushed stainless steel
- Ref. 52740 - Manganese grey
- Ref. 52741 - White RAL 9016
- Ref. 52742 - Pastel blue RAL 5024



## OPTION



## TANK LID FOR SOAP DISPENSER

- Prevents gel evaporation
- Dim.: 115 x 50 x 5 mm
- Ref. 52485 - Lid



## CENTRE FEED HAND TOWEL DISPENSER 450 FORMAT

- Capacity: rolls up to 450 format max. Ø 210 mm x H 210 mm
- Integrated paper cutter



- Ref. 52735 - Brushed stainless steel
- Ref. 52736 - Manganese grey
- Ref. 52737 - White RAL 9016
- Ref. 52738 - Pastel blue RAL 5024



## HAND TOWEL DISPENSER 600 SHEETS

- Capacity: up to 600 folded hand towel sheets (24 x 26 cm)
- Integrated flow regulator

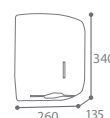

- Ref. 52675 - Brushed stainless steel
- Ref. 52728 - Manganese grey
- Ref. 52729 - White RAL 9016
- Ref. 52730 - Pastel blue RAL 5024

# Rollado INDISPENSABLE

## ROLLADO

### CENTRE FEED HAND TOWEL DISPENSER 450 FORMAT

- Polyethylene
  - Central feed for roll
  - Takes rolls with max Ø of 220 and max. height of 240 mm
- Ref. 52099 - Transparent grey



Integrated flow regulator



Key lock

Discover our folded paper hand towel dispensers (p.84 to 88)

# Bobino CLEANLINESS AT YOUR FINGERTIPS



## BOBINO

### WALL MOUNTED PAPER ROLL HOLDER

- Anti-UV powder-coated steel
- For all rolls up to Ø 350
- Wall mounted

□ Ref. 53246 - White

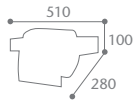

## BOBINO

### WALL MOUNTED PAPER ROLL HOLDER

- Anti-UV powder-coated steel
- For all rolls with Ø up to 250mm
- Paper cutting blade

□ Ref. 53245 - White

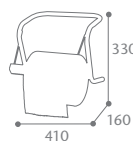

Discover our "Special Industry" bins (p. 78-79)



Bag holder with 4 plastic clips



## BOBINO

### MOBILE SACK & PAPER ROLL HOLDER

- Anti-UV powder-coated steel
- For all rolls with Ø up to 360mm
- Paper cutting blade
- 2 plastic wheels

□ Ref. 52685 - White

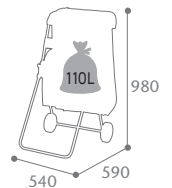

## BOBINO

### FREE STANDING PAPER ROLL HOLDER

- Anti-UV powder-coated steel
- For all rolls with Ø up to 450mm
- Paper cutting blade

□ Ref. 53244 - White

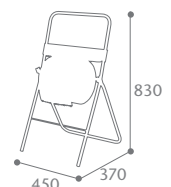



# Hygiene Dispenser



# Sanimains

### Post + stand

- Anti-UV powder-coated steel
- Drip recovery shelf
- Freestanding on 4 height adjustable feet, or 4 point ground fixing
- Vandal-proof: dispenser fixed on the stand
- Information plate: supplied with A4 adhesive vinyl (French text)

**AUTOMATIC CONTACT-FREE**



**ECONOMICAL! IT DISPENSES THE RIGHT DOSE WITH EACH USE**

Wide opening: quick and easy refilling

### FREE-STANDING AUTOMATIC HAND DISINFECTION STATION

#### Dispenser

- White ABS plastic
- 0.850 L tank
- 4 LR6 batteries (not included)
- Automatic infra-red sensor distribution
- Consumable control window
- Flow rate adjustment: 0.5 to 2.5 ml
- Key lock

- Ref. 52515 - White RAL 9016
- Ref. 52516 - Manganese grey

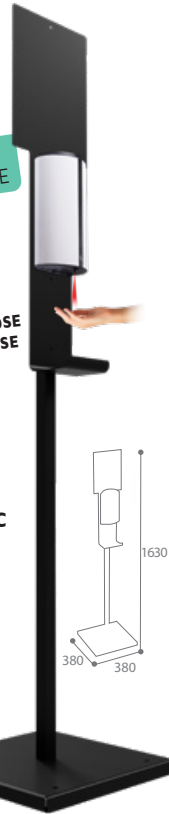

**ELBOW-OPERATED UNBREAKABLE**



Premium quality push bar

### FREE-STANDING, ELBOW-OPERATED HAND DISINFECTION STATION

#### Dispenser

- Translucent unbreakable polycarbonate 3 mm
- 0.850 L tank
- Anti-drip valve distribution system
- Consumable control window
- Flow rate: 1 ml with each press
- Key lock

- Ref. 52513 - White RAL 9016
- Ref. 52514 - Manganese grey



**PEDAL-OPERATED CONTACT-FREE**

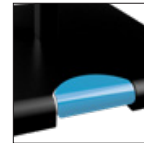

Gel dispensed by operating the visible blue pedal

### FREE-STANDING, PEDAL-OPERATED HAND DISINFECTION STATION

#### Dispenser

- White ABS with antistatic additive
- 1.1 L tank
- Pedal-operated
- Anti-drip system
- Consumable control window
- Flow: 1.3 ml with each press
- Key lock

- Ref. 52490 - White RAL 9016
- Ref. 52491 - Manganese grey



## ACCESSORIES

### SANIMAINS

#### PACK OF 10 STICKERS

- Colour vinyl sticker (French text)
- Suitable for indoor and outdoor use
- Can be affixed to all types of surfaces

Facilitates identification of disinfection stations.

Ref. 50290 - 210 x 297 mm

Ref. 50291 - 120 x 84 mm

50291



50290



# Cubagel

## CONTACT-FREE



- + INTENSIVE USE
- + GEL STORAGE
- + PRM

### CUBAGEL

#### FREE-STANDING PEDAL / HANDLE ACTIVATED DISINFECTION STATION FOR 5L DRUM

- Anticorrosion treated and anti-UV powder coated
- Activation by means of AISI 304 (18/10) stainless steel handle and/or pedal
- Flow-rate adjustment by means of adjusting spindle
- Secure locking using a triangular key lock
- Drip recovery shelf
- Supplied with a 5ml pump to fit a Ø42mm drum cap
- 4 adjustable feet and 4 holes for possible floor anchoring

- Ref. 52495 - White RAL 9016/ Blue RAL 5015



1 x 5L DRUM + storage for 2 x 5L drums in the dispenser

Indoor / Outdoor use Anticorrosion

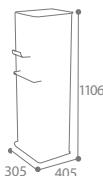

- + SMALL FOOTPRINT



### CUBAGEL

#### FREE-STANDING PEDAL ACTIVATED HAND DISINFECTION STATION FOR BOTTLE

- Anti-UV powder-coated steel.
- Foot pedal activated
- For all types of bottles from 300 ml to 1 L (Ø max. 100 mm)
- Positioning the bottle: height adjustment of the inner turntable
- Flow-rate adjustment through pump pre-compression
- Security locked using a triangular key lock
- Drip recovery shelf
- Supplied with a 2ml pump to fit Ø28mm bottle cap
- 4 floor protection pads/4 holes for possible floor anchoring

- Ref. 52492 - White RAL 9016/ Blue RAL 5015

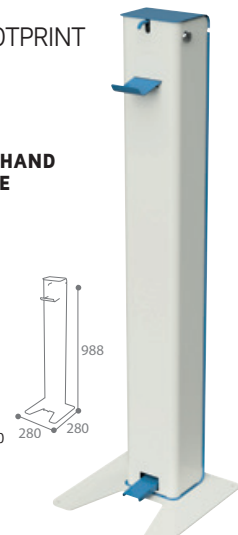

\* Drum not supplied.

# Sanimains AUTOMATIC CONTROL

## SANIMAINS

### WALL-MOUNTED OR POST-MOUNTED HAND DISINFECTION STATION

#### Wall bracket

- Anticorrosion treated and anti-UV powder-coated steel
- Drip recovery shelf
- Discrete locking system on the wall support: with the key below the dispenser
- 4-point wall mounting system
- Supplied with 120x80mm self adhesive vinyl (French text)

#### Dispenser

- White ABS plastic
- 0.850 L tank
- Automatic infra-red sensor dispensing mechanism
- Key for locking the tank from above
- Flow rate adjustment: 0.5 ml to 2.5 ml
- Takes all types of soap, including hydroalcoholic gel (except microbeads)
- Powered by 4 LR6 batteries (not supplied)

- Ref. 52520 - Wall-mounting bracket - Manganese grey
- Ref. 52521 - Post-mounting bracket - Manganese grey

AUTOMATIC  
CONTACT-FREE



Wall mounted



Post-mounted system  
(Post not supplied)

## COMPATIBLE WITH HYDROALCOHOLIC GELS\*



## SANIMAINS

ELBOW-OPERATED  
UNBREAKABLE

### WALL-MOUNTED OR POST-MOUNTED, ELBOW-OPERATED HAND DISINFECTION STATION

#### Stand

- Anticorrosion treated and anti-UV powder-coated steel
- Drip recovery shelf
- Information plate
- Supplied with 120x80mm self adhesive vinyl (French text)

#### Dispenser

- Translucent unbreakable polycarbonate 3 mm
- 0.850 L tank
- Anti-drip valve distribution system
- Visualisation of level as casing is translucent
- Flow-rate: 1 ml with each press
- Key lock

- Ref. 52470 - Wall-mounting bracket - Manganese grey
- Ref. 52471 - Post-mounting bracket - Manganese grey



Wall mounted



Post-mounted system  
(Post not supplied)



# Hygiface FACILITATES ACCESS TO SELF-SERVICE MASKS



## HYGIFACE

### WALL-MOUNTED OR FREE-STANDING MASK DISPENSER - 50 MASKS

- Anti-UV powder-coated steel.
- 2-point wall-mounting system or free-standing
- Takes 1 box of 50 masks - not provided
- Screen printing on the front
- Refill from the top

- Ref. 52336 - White RAL 9016
- Ref. 52337 - Manganese grey

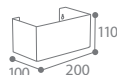

\* Except microbeads. Gel not supplied



Hygiene

Dispenser and bin



# Gaïa

YOUR ALLY IN THE FIGHT AGAINST PERIOD POVERTY



4 compartments

100% CUSTOMISABLE WIDE AREA ON THE FRONT (MARKING ON REQUEST)

A solution 100% feminine  
A sustainable and recyclable sanitary product dispenser

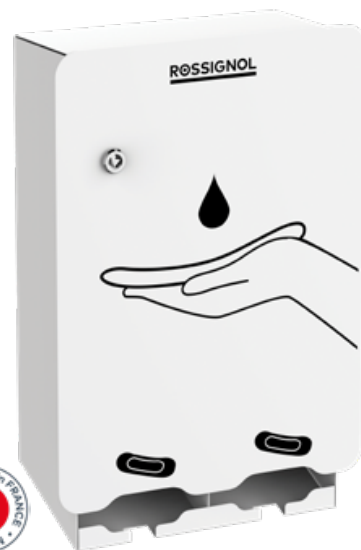

2 compartments



## GAÏA

### DISPENSER FOR FREE DISTRIBUTION OF SANITARY PRODUCTS: 2 OR 4 COLUMNS

- Anti-UV powder-coated steel
- Locking with Ø7mm triangular key lock
- 3-point wall mounting system
- To refill: open door and refill from top of column (individually wrapped consumables not supplied)
- 2 compartment version: 2 columns of 50 sanitary towels
- 4 compartment version: 2 columns of 50 sanitary towels + 1 column 100 tampons + 1 column 100 tampons with applicator
- Calibrated apertures to the front to regulate flow
- Supplied with installation and filling instructions
- Screenprinted product instructions on the front

- Ref. 51921 - Traffic white RAL 9016 - 2 compartments
- Ref. 51920 - Traffic white RAL 9016 - 4 compartments

# Oleane

## OLEANE SANITARY BAG DISPENSER

- ABS
- Front opening: easy to grasp the bags
- Key lock

Ref. 52540 - White



## CONSUMABLES

### FEMINA

#### BAGS FOR SANITARY WASTE

- Plastic sanitary waste bags
- 20 bags per refill (48 refills/mastercarton)
- Consumable for the OLEANE sanitary bag dispenser (Ref. 52540)

Ref. 51220 - Pack of 960 bags - White



## LEGISLATION

### FEMINE HYGIENE



#### Article R232-5 to R. 232-5-9:

Toilets must be fitted out in such a way that they do not give off any smell, be equipped with water and toilet paper...

Women's toilet must have a container for sanitary waste.

**Article R4228-10:** In establishments employing mixed staff, toilets are separate for female and male staff. Fight against period poverty by offering sanitary equipment free of charge (see p 110).



# Feminine hygiene



## CONSUMABLES

### FEMINA

#### SANITARY WASTE BAGS

- Pack of 1000 bags, 40 packs of 25 paper bags
- Consumables for the Blanka, Stella, Manga and Axos feminine hygiene dispensers bins

Ref. 99099 - Pack of 1000 bag

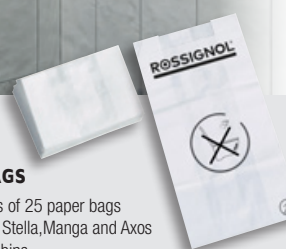

#### SANITARY BAG DISPENSER

- Anti-UV powder coated steel or brushed stainless steel 430
- Key lock
- Takes 200 sanitary bags (Femina Ref. 99099)



#### WALL MOUNTED FEMININE HYGIENE BIN WITH BAG DISPENSER 10L

- Anti-UV powder coated steel
- Lock and key
- Lids with pads. Bag clamp
- Dispenser takes 100 sanitary bags (Femina 99099)

Range Colour	Sanitary bag dispenser	Wall mounted feminine hygiene bin with bag dispenser 10l
<b>BLANKA</b> <input type="checkbox"/> White RAL 9016	58106	51354
<b>STELLA</b> <input checked="" type="checkbox"/> Metal grey RAL 9006	58107	51355
<b>MANGA</b> <input checked="" type="checkbox"/> Manganese grey	58108	51356
<b>AXOS</b> <input type="checkbox"/> Brushed stainless steel 430	58118	-

# Femina CONTACT-FREE, PREVENTS CONTAMINATION



Modesty chute to conceal contents

### FEMINA

#### SANITARY PEDAL BIN 20L

- ABS
- Space saving due to its elongated form
- Pedal operated to avoid any hand contact

Ref. 91939 - White



## AUTOMATIC

### FEMINA

#### SENSOR ACTIVATED SANITARY BIN 20L

- ABS
- Power switch and indicator light indicating operation
- Modesty chute concealing contents
- Integrated sensor near the pedal enables automatic opening: 4AA alkaline batteries (not supplied)
- Lid opens within 0.5 second when foot is within 10 to 15cm of the pedal.
- Automatic closing of the lid after use. Lid stay open as long as the foot remains near the sensor.
- Integrated sack holder to hold the bag in place

Ref. 91938 - White



Opened by infrared sensor



# Hera ODOURLESS AND HYGIENIC

### HERA

#### SANITARY PEDAL BIN 15L

- Polypropylene
- Pedal operated
- Elongated shape
- Removable lid
- Handle for manual opening

Ref. 91885 - Grey/White

Ref. 91886 - Grey/Matt black

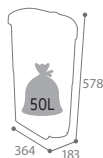

Modesty chute



Space reserved for the installation of an odour neutralizer (not supplied)



## Hygiene Bin



# Blanka • Stella • Manga • Axios

□ White RAL 9016  
(UV-resistant powder-coated steel)

■ Metal Grey RAL 9006  
(UV-resistant powder-coated steel)

■ Manganese grey  
(UV-resistant powder-coated steel)

□ Brushed stainless steel F17

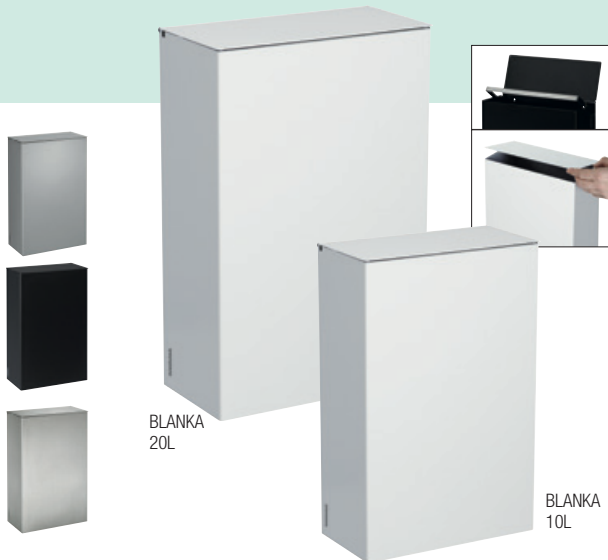

BLANKA 20L

BLANKA 10L

### WALL-MOUNTED BIN - 10 L AND 20 L

- Lid with plastic pads
- With or without bag clamp



Discover our matching range of toilet paper and hand towel dispensers (p.84)



BLANKA 40L

BLANKA 20L

### REMOVABLE WALL-MOUNTED BIN 20 L AND 40 L

- Unhook to empty
- Wall-mounting spacers supplied
- Possibility of placing a bag inside the bin using the bag clamp (optional)

Discover our bag clamps (p 51)



Range/Colour	Wall-mounted bin 10 L		Wall-mounted bin 20 L		Removable wall-mounted bin	
	Without bag clamp	With bag clamp	Without bag clamp	With bag clamp	"ARKEA" 20L	"ARKEA" 40L
<b>BLANKA</b> □ White RAL 9016	51362	51345	51351	51348	58449	58459
<b>STELLA</b> ■ Metal grey RAL 9006	51359	51346	51352	51349	58447	58457
<b>MANGA</b> ■ Manganese grey	51366	51347	51353	51350	58448	58458
<b>AXIOS</b> □ Brushed stainless steel F17	51363	51371	51373	51372	56870	56872



## Essencia

VALUE FOR MONEY

### ESSENCIA

#### PEDAL BIN

- Stainless steel or white powder-coated steel
- Inner plastic bucket with metal handle
- Non tilt base



- Ref. 90447 - Stainless steel - 3L
- Ref. 90528 - Stainless steel - 5L
- Ref. 90577 - Stainless steel - 14L
- Ref. 90529 - White RAL 9016 - 3L
- Ref. 90535 - White RAL 9016 - 5L
- Ref. 90576 - White RAL 9016 - 14L



5L

14L



3L

ROSSIGNOL PRO



# Sanelia



Polypropylene hinge  
(20 L and 30 L with  
integrated slow close

TOP SELLER



Double metal handle  
(20 L and 30 L)



30L

## SANELIA

### PEDAL BIN

- Brushed stainless steel or anti-UV powder coated steel
- Removable inner plastic bucket (20L and 30L)
- Vent holes in the bucket (20L and 30L)
- Galvanised steel linkage
- Non-tilt plastic base (3 L, 5 L, 14 L)
- Polypropylene rim on the base
- Non-slip plastic pedal with kickplate
- Sticker (Ref. 50292) optional
- **HACCP compliant**

20L

14L

5L

Colour	3L	5L	14L	20L	30L
Blue smooth matt RAL 5024	90376	90387	90438	90334	90339
Manganese grey	90377	90388	90439	90335	90340
Traffic white RAL 9016	90113	90114	90115	90361	90351
Stainless steel	90123	90124	90125	90360	90350
Matt beige grey texture RAL 1019	90165	90166	90167	90173	90174

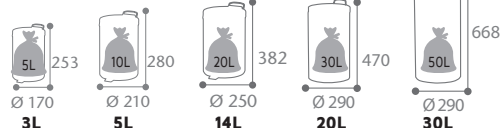

Discover our "Jetez vos dechets" sticker  
Ref 50292 (p13) (French text)

TRY A LITTLE COLOUR!



CUSTOMISABLE SUBJECT TO ESTIMATE



Hygiene

Bin



# Clap

- Swing lid
- Remove the lid to empty
- Accessory: wall mounting plate Ref. 58875

## CLAP "GREEN"

### SWING LID BIN

- Recycled polypropylene

- Ref. 91120 - Black - 5L
- Ref. 91121 - Black - 10L
- Ref. 91122 - Black - 18L
- Ref. 91123 - Black - 35L
- Ref. 91124 - Black - 50L



50L

## CLAP

### SWING LID BIN

- Polypropylene

- Ref. 91160 - White - 5L
- Ref. 91161 - White - 10L
- Ref. 91162 - White - 18L
- Ref. 91163 - White - 35L
- Ref. 91164 - White - 50L



50L

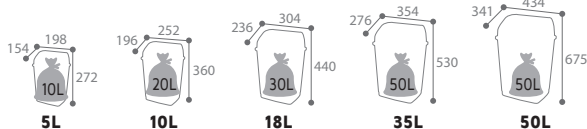
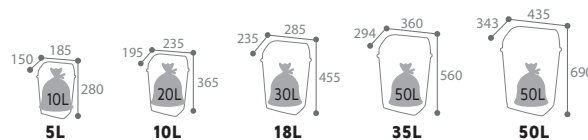

## ACCESSORIES



### WALL MOUNTING PLATE FOR SWING LID BIN

- Ref. 58875 - Galvanised steel

Discover our CLAP "Special waste sorting" bins (p.18)



# Prima

## PRIMA

### PEDAL BIN

- Polypropylene
- Inner bucket with plastic handle
- HACCP compliant

- Ref. 91150 - White - 5L
- Ref. 91151 - White - 7L
- Ref. 91152 - White - 11L
- Ref. 91153 - White - 18L
- Ref. 91154 - White - 30L
- Ref. 91155 - White - 50L

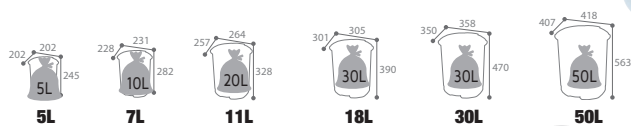

50L

30L

7L

Discover our "Jetez vos déchets" sticker Ref 50292 (p13) (French text)



## How to choose your hand dryer?



Range	AERY PRESTIGE	AERY PLUS	AERY FIRST	PULSEO	OLEANE	ZEFF	ZELIS	STORMA	AIRSMILE
<b>Performance</b>	★★★★★	★★★★	★★★	★★★	★★★	★★★★★	★★★★★	★★★★	★★★★
<b>Use</b>	Intensive	Intensive	Moderate	Moderate	Moderate	Intensive	Intensive	Moderate	Moderate
<b>Vandal-proof</b>	ABS casing	ABS casing	ABS casing	Stainless steel casing AISI 304 (18/10)	ABS casing	Brushed steel casing AISI 304 (18/10)	Brushed steel casing AISI 304 (18/10)	Stainless steel casing AISI 304 (18/10)	ABS casing
<b>Drying time</b>	7 to 10 seconds	7 to 10 seconds	7 to 10 seconds	29 seconds	29 seconds	10 to 15 seconds	10 to 15 seconds	10 to 15 seconds	10 to 15 seconds
<b>Automatic Start</b>	✓	✓	✓	✓	✓	✓	✓	✓	✓
<b>Sound Level</b>	65 to 72 dB	65 to 72 dB	65 to 72 dB	75 dB	75 dB	72 dB	76 dB	72 dB	76 dB
<b>Voltage</b>	220 / 240 V	220 / 240 V	220 / 240 V	220 / 240 V	220 / 240 V	220 / 240 V	220 / 240 V	220 / 240 V	220 / 240 V
<b>PRM (with adapted facilities)</b>	-	-	-	♿	♿	♿	♿	♿	♿
<b>Air output speed</b>	342 km/h	342 km/h	324 km/h	108 km/h	108 km/h	216 km/h	320 km/h	245 km/h	320 km/h
<b>Air temperature</b>	20/40°C	20/40°C	20/40°C	52°C	52°C	20/40°C	20/40°C	20/40°C	20/40°C
<b>Heating Element</b>	Activate / Deactivate	Activate/ Deactivate	Activate/ Deactivate	-	-	Activate/ Deactivate	Activate/ Deactivate	-	Activate/ Deactivate
<b>Electrical protection</b>	Class I - IP24	Class I - IP24	Class II - IP24	Class I - IPX1	Class I - IPX1	Class II - IP13	Class II - IP13	Class II - IP13	Class II - IP24
<b>Compliance</b>	CE - RoHS	CE - RoHS	CE - RoHS	CE - RoHS	CE - RoHS	CE - RoHS	CE - RoHS	CE - RoHS	CE - RoHS
<b>Hygiene</b>	HEPA filter 200ml water recovery tray and/ or mains drains connection	HEPA filter 800ml water recovery tray	HEPA filter 400ml water recovery tray	-	-	-	-	-	Water recovery tray 400 ml
<b>Colour Customisation</b>	-	-	-	-	-	✓	✓	-	-
<b>Why this product?</b>	Antibacterial automatic sterilisation	Antibacterial Impact resistant	Good price Performance ratio	360° swivelling nozzle	360° swivelling nozzle	Small footprint Impact resistant	Heavy duty Impact resistant	Suitable for hotel and catering	Suitable for PRM

**Compliance with standards in force relating to the installation of electrical appliances:**

- French Standard C 15-100 from AFNOR - French Standards Association
- European standard HD 384 from CENELEC - European Committee for Electrotechnical Standardization
- International standard 60364 by IEC - International Electrotechnical Commission

**DISCOVER ALL OUR HAND DRYERS  
P. 98 TO 101**



Hygiene Hand dryer

# Aery Prestige

+ ULTRA-FAST DRYING

**AERY PRESTIGE has a HEPA filter and an automatic sterilisation system. With its brushless motor technology and its features, it is especially recommended for intensive use.**

## AERY PRESTIGE

**AUTOMATIC HAND DRYER - 750W**

- ABS casing
- Antibacterial
- Vandal-proof
- Automatic start
- 750 W brushless technology motor
- Automatic UV sterilisation (1h/24h)
- Sound level 65 to 72 dB
- Voltage: 220-240 V
- Drying time: 7 to 10 seconds
- Air output speed: 342km/h
- Air temperature: 20/40°C
- Heating element: can be switched on/off
- Electrical Protection Class I - IP24
- CE - RoHS
- Built-in HEPA filter sold as consumable (Ref. 51590)

- Ref. 51676 - White
- Ref. 51677 - Metallic grey



White

Metallic grey



- + HEATING ELEMENT CAN BE DEACTIVATED TO REDUCE POWER CONSUMPTION
- + ANTIBACTERIAL
- + AUTOMATIC STERILISATION



Water recovery tray 200ml and/or mains drainage connection

### CONSUMABLES

#### FILTER (AERY PRESTIGE)

- Purifies the air: filters at least 99.9% of bacteria
- To be changed every 4 months for optimum hygiene quality

Ref. 51590 - HEPA filter\*



# Aery Plus & First

VERY GOOD PRICE/PERFORMANCE RATIO

+ ULTRA-FAST DRYING

## AERY PLUS & AERY FIRST

**AUTOMATIC HAND DRYER**

- ABS casing
- Vandal-proof
- Automatic start
- Possible deactivation of the element for minimum power consumption
- Sound level 65 to 72 dB
- Drying time: 7 to 10 seconds
- Air temperature: 20/40°C
- Heating element: can be switched on/off
- Voltage: 220-240 V
- Consumable: Optional HEPA filter (Ref. 51589)

#### Model AERY PLUS - 750W

- Antibacterial
- 750 W brushless technology motor
- Air output speed: 342km/h
- Electrical Protection Class I - IP24
- CE - RoHS

#### Model AERY First - 800W

- Monoblock motor with brushes 800W
- Air output speed: 324km/h
- Electrical Protection Class II - IP24
- CE - RoHS

- Ref. 51675 - Aery PLUS
- Ref. 51674 - Aery FIRST



Model AERY PLUS

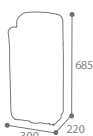

Inner water recovery tray 800ml



Model AERY PLUS:  
On/off switch  
+ hot/cold air  
+ air speed



Model AERY FIRST:  
On/off switch

### CONSUMABLES

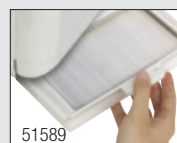

51589

#### HEPA HAND DRYER FILTER

- Purifies the air: Filters at least 99.97% of particles with a diameter over or equal to 0.3 µm
- To be changed every 4 months

Ref. 51589 - White - For AERY FIRST (Ref. 51674) and AERY PLUS (Ref. 51675) hand dryers

\*High Efficiency Particulate Air

# Pulseo 360° SWIVELLING NOZZLE

- + CAN BE USED AS A HAIR DRYER
- + VANDAL-PROOF

## PULSEO

### HORIZONTAL AUTOMATIC HAND DRYER - 2300W

- Powder-coated steel or AISI 304 (18/10) brushed stainless steel
- Infra-red automatic start
- Sound level: 75 dB
- Drying time: 29 seconds
- Air output speed: 108km/h
- Air temperature: 52°C
- Infra-red sensor system
- Voltage 220/240 V
- Frequency: 50Hz
- Electrical Protection Class I - IPX1
- CE and ROHS

Ref. 51671 - White

Ref. 51672 - Brushed stainless steel



# Oleane VERY GOOD PRICE/PERFORMANCE RATIO

- + CAN BE USED AS A HAIR DRYER

## OLEANE

### HORIZONTAL AUTOMATIC HAND DRYER - 2300W

- ABS casing
- 360° swivelling nozzle
- Infra-red automatic start
- Sound level: 75 dB
- Drying time: 29 seconds
- Air output speed: 108km/h
- Air temperature: 52°C
- Voltage: 220/240V
- Frequency: 50Hz
- Electrical Protection Class I - IPX1
- CE and ROHS

Ref. 52501 - White

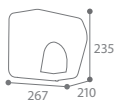



Hygiene

Hand dryer



# Zeff

SMALL FOOTPRINT

## HORIZONTAL AUTOMATIC HAND DRYER - 1150W

- AISI 304 brushed or powder-coated stainless steel (18/10)
- Vandal-proof: ultra-resistant casing
- Automatic start
- Sound level 72 dB
- Voltage: 220/240V
- Frequency: 50/60Hz
- Drying time: 10 to 15 seconds
- Air output speed: 216km/h
- Air temperature: 20/40°C
- Heating element: can be switched on/off
- Electrical Protection Class II - IP13
- CE and ROHS

- Ref. 51424 - Pastel blue RAL 5024
- Ref. 51410 - Brushed stainless steel
- Ref. 51411 - Manganese grey
- Ref. 51412 - White RAL 9016

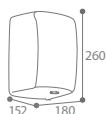

+ VANDAL-PROOF

+ SUITABLE FOR INTENSIVE USE

+ HEATING ELEMENT CAN BE DEACTIVATED TO REDUCE POWER CONSUMPTION



Discover our CLARA range (p88)

# Zelis

VANDAL-PROOF

+ HEATING ELEMENT CAN BE DEACTIVATED TO REDUCE POWER CONSUMPTION



+ SUITABLE FOR INTENSIVE USE

## HORIZONTAL AUTOMATIC HAND DRYER - 1400W

- AISI 304 brushed or powder-coated stainless steel (18/10)
- Vandal-proof: ultra-resistant casing
- Automatic start
- Sound level: 76 dB
- Voltage: 220/240V
- Frequency: 50/60Hz
- Drying time: 10 to 15 seconds
- Air output speed: 320km/h
- Air temperature: 20/40°C
- Heating element: can be switched on/off
- Electrical Protection Class II - IP13
- CE and ROHS

- Ref. 51766 - Pastel blue RAL 5024
- Ref. 51678 - Brushed stainless steel
- Ref. 51768 - Manganese grey
- Ref. 51769 - White RAL 9016

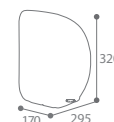

TRY A LITTLE COLOUR! CUSTOMISATION SUBJECT TO ESTIMATE - DISCOVER OUR STANDARD COLOUR CHART P 8

# Storma



SUITABLE FOR HOTEL AND CATERING

- + SMALL FOOTPRINT
- + QUIET

## STORMA

### HORIZONTAL AUTOMATIC HAND DRYER - 1150W

- Stainless steel casing AISI 304 (18/10)
- Automatic start
- Sound level: 72 dB
- Drying time: 10 - 15 seconds
- Air output speed: 245km/h
- Air temperature :
- Heating element
- Voltage: 220/240 V
- Frequency: 50/60Hz
- Electrical Protection: Class II - IP13
- CE and ROHS

MODIFICATION

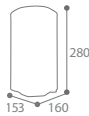

- Ref. 51684 - Brushed stainless steel
- Ref. 51685 - Textured mat black

MODIFICATION



- + MINIMISED POWER CONSUMPTION



# Airmile



SUITABLE FOR PRM

- + EASY-TO-CLEAN WATER RECOVERY TRAY

## AIRSMILE

### HORIZONTAL AUTOMATIC HAND DRYER - 1400W

- ABS plastic casing
- Automatic start
- Sound level: 76 dB
- Heating element can be switched on/off
- Voltage: 220/240V
- Frequency: 50Hz
- Drying time: 10 to 15 seconds
- Air output speed: 320km/h
- Air temperature: 20°/40°C
- Electrical Protection Class II - IP24
- CE and ROHS

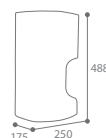

- Ref. 51682 - White
- Ref. 51683 - Metallic grey



Air temperature setting

- + HEATING ELEMENT CAN BE DEACTIVATED TO REDUCE POWER CONSUMPTION



Water recovery tray 400ml



Hygiene

Bathroom equipment



# Epure

TIMELESS AND  
STURDY BATHROOM  
EQUIPMENT WITH A  
CONTEMPORARY LOOK



### TOILET PAPER ROLL HOLDER WITH SHELF

- Anti-corrosion treated and anti-UV powder-coated steel
- 3-point wall-mounting system (stainless steel screws and screw-covers provided)
- Fits all types of rolls (up to Ø 13cm x 9.5cm)
- Flow regulator
- Integrated shelf to accommodate all types of objects

■ Ref. 52020 - Manganese grey



### TOILET PAPER STORAGE UNIT

- Anti-corrosion treated and anti-UV powder-coated steel
- 2-point wall-mounting system (stainless steel screws and screw-covers provided)
- Fits all types of rolls (up to Ø 13cm x 9.5cm)
- Holds up to 3 rolls of toilet paper

■ Ref. 52021 - Manganese grey



### WALL MOUNTED TOILET BRUSH & HOLDER

- Support in Anti-corrosion treated and anti-UV powder-coated steel
- 2 point-wall-mounting system (stainless steel screws and screw-covers provided)
- Removable polystyrene plastic pot
- Toilet brush with black bristles supplied

■ Ref. 52022 - Manganese grey

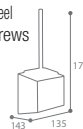

### WALL-MOUNTED SOAP HOLDER

- Anti-corrosion treated and anti-UV powder-coated steel
- 2-point wall-mounting system (stainless steel screws and screw-covers provided)
- Perforated base: avoid the accumulation of water

■ Ref. 52023 - Manganese grey



### WALL-MOUNTED ACCESSORY HOLDER

- Anti-corrosion treated and anti-UV powder-coated steel
- 2-point wall-mounting system (stainless steel screws and screw-covers provided)
- Perforated base: avoid the accumulation of water

■ Ref. 52024 - Manganese grey

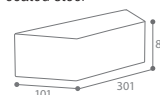

### WALL-MOUNTED SOAP DISPENSER

- Anticorrosion treated and anti-UV powder coated steel bottle holder
- 2-point wall-mounting system (stainless steel screws and screw-covers provided)
- 0.3L polystyrene plastic bottle
- Chromed plastic pump and nozzle

■ Ref. 52024 - Manganese grey



### DOUBLE OR TRIPLE HOOK

- Anti-corrosion treated and anti-UV powder-coated steel
- 2-point wall-mounting system (stainless steel screws and screw-covers provided)

■ Ref. 52026 - 2 hooks - Manganese grey

■ Ref. 52027 - 3 hooks - Manganese grey

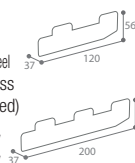

TRY A LITTLE COLOUR! CUSTOMISABLE SUBJECT TO ESTIMATE - DISCOVER OUR STANDARD SHADES P.8



## DIFUSEO PROGRAMMABLE FRAGRANCE DIFFUSER

- ABS plastic
- Dispensing intervals programmable between 5 min and 4 h.
- Dispensing options: Day/Night/24 hours
- Key locking system
- Wall mounting fixings supplied / Sold without fragrances / 2xLR20 batteries not supplied
- Range: 8m

Ref. 51576 - White



### CONSUMABLES

#### REFILL FOR FRAGRANCE DISPENSER

- Contents 300 ml (up to 3000 sprays possible)
- Eliminates unwanted odours
- Consumable for the fragrance dispenser (Ref. 51576)

Ref. 51210 - Batch of 3 lemon fragrance refills  
Ref. 51211 - Batch of 3 jasmine fragrance refills  
Ref. 51213 - Batch of 3 marine fragrance refills



Programmed via digital display



+ SILENT



## MAJESTIC REMOVABLE ANTIBACTERIAL TOILET SEAT

- High quality non scratch thermoset (UF)
- Antibacterial treatment
- Double soft-fall hinge
- AISI 304 stainless steel cover and screws supplied
- Adjustable individual hinges
- Installation dimensions: 20 to 200mm
- Weight 1.9kg

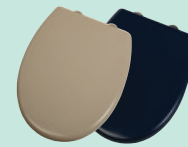

- Ref. 51592 - White
- Ref. 51475 - Beige grey
- Ref. 51476 - Blue

Removable with 1 click:  
optimal cleaning

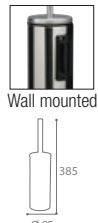

NEW

## TULIA WALL-MOUNTED OR FREE-STANDING ANTI- BACTERIAL BRUSH & HOLDER

- Stainless steel 430 - Polypropylene plastic
- Removable bucket
- Adapted for PRM use

Ref. 51827 - Stainless steel

Ref. 51821 - White RAL 9016

Ref. 51822 - Manganese grey

Ref. 51823 - Blue RAL 5001 smooth mat.

Ref. 51829 - Matt grey texture RAL 1019

+ TOP OF THE RANGE

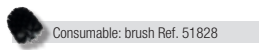

Consumable: brush Ref. 51828

## SANEA FREE-STANDING TOILET BRUSH & HOLDER

- Stainless steel/plastic handle

Ref. 51611 - Stainless steel/White brush

Ref. 51596 - Stainless steel/Black brush

Consumables:  
- white brush Ref. 51837  
- black brush Ref. 51595

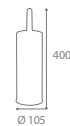

## RIVEA WALL-MOUNTED OR FREE-STANDING TOILET BRUSH & HOLDER

- Stainless steel/Plastic toilet brush
- Adapted for PRM use

Ref. 51698 - Stainless steel

Consumable: brush Ref. 51837

Wall mounted

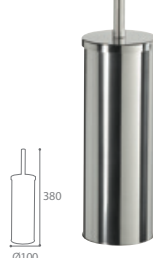

## SANIPLA WALL-MOUNTED OR FREE- STANDING TOILET BRUSH & HOLDER

- Stainless steel/Plastic toilet brush
- Adapted for PRM use

Ref. 51708 - White



TRY A LITTLE COLOUR! CUSTOMISABLE SUBJECT TO ESTIMATE



## DUPLEX REMOVABLE SILENT ANTIBACTERIAL TOILET SEAT

- Thermoplastic (polypropylene): unbreakable
- Antibacterial treatment
- Double soft fall hinge
- Removable in one click
- Recyclable
- Installation dimensions: 80 to 200mm
- Weight: 1.3kg

Ref. 51699 - White

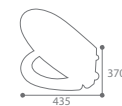

Removable in 1 click:  
optimal cleaning



## SANIPLA TOILET SEAT

- Thermoplastic (polypropylene)
- Plastic hinges
- Fixing supplied
- Installation dimensions: 100 to 163mm
- Weight: 0.8kg

Ref. 51679 - White



MODIFICATION





# Biska

SOLUTIONS FACILITATING ACCESS FOR PEOPLE WITH REDUCED MOBILITY

Legislation see p. 110

AISI 304 Stainless steel (18/10)



150 KG

### STRAIGHT GRAB RAIL

- Dim: L (305/445/655) x P80 x H55

- Ref. 51845 - Chrome - 25 cm
- Ref. 51848 - White - 25 cm
- Ref. 51846 - Chrome - 40 cm
- Ref. 51849 - White - 40 cm
- Ref. 51847 - Chrome - 60 cm
- Ref. 51850 - White - 60 cm

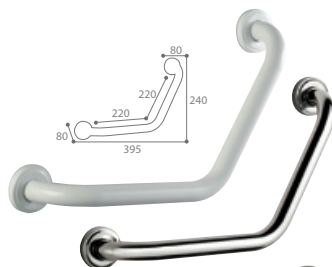

150 KG

### ANGLED GRAB RAIL 22 X 22 CM

- Ref. 51851 - AISI 304 Stainless steel (18/10)
- Ref. 51852 - White

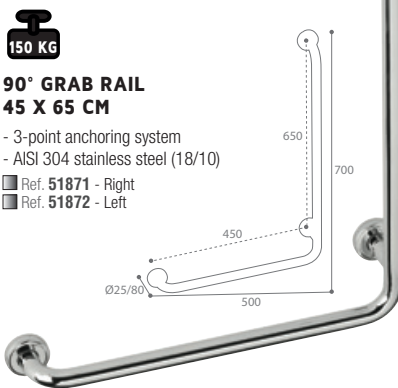

150 KG

### 90° GRAB RAIL 45 X 65 CM

- 3-point anchoring system
- AISI 304 stainless steel (18/10)

- Ref. 51871 - Right
- Ref. 51872 - Left

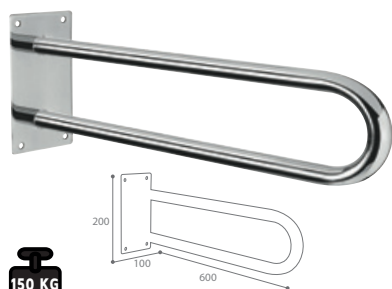

150 KG

### STATIC DOUBLE GRAB RAIL - 60CM

- Ref. 51853 - AISI 304 stainless steel (18/10)
- Ref. 51854 - White

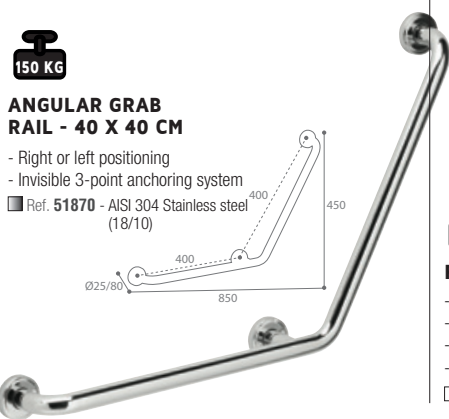

150 KG

### ANGULAR GRAB RAIL - 40 X 40 CM

- Right or left positioning
- Invisible 3-point anchoring system

- Ref. 51870 - AISI 304 Stainless steel (18/10)

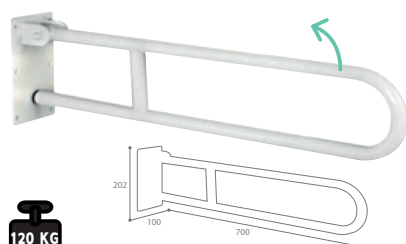

120 KG

### FOLD UP GRAB RAIL 70 CM

- Ref. 51855 - AISI 304 stainless steel (18/10)
- Ref. 51856 - White



150 KG

### ADJUSTABLE STOOL

- Can be used in wet areas
- Polyethylene seat
- Aluminium feet
- Non-slip pads
- Adjustable height: 348 to 576 mm

- Ref. 51858 - White

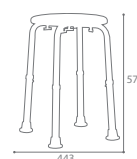

CAN BE FOLDED UP FLUSH WITH THE WALL



150 KG

### FOLD UP SHOWER SEAT

- Wall mounted shower seat
- Suitable for use in wet areas
- White cast aluminium wall bracket
- Seat in white ABS

- Ref. 51857 - White

### CLINY WALL-MOUNTED OR FREE-STANDING TOILET BRUSH & HOLDER

- Polypropylene
- Concealed toilet brush

- Ref. 51711 - White

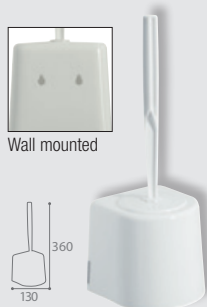

### AUXILIA CONTACT-FREE TOILET SEAT

- High quality non scratch thermoset (UF)
- Antibacterial treatment
- Integrated soft-fall hinge
- Easy to install: 2 mounting methods (from above and from below)
- Installation dimensions: 81 to 169 mm
- Weight: 0.936 kg

- Ref. 51586 - White



## UTIL

### HOOK

- Powder coated steel or chrome steel

#### SINGLE HOOK

- Ref. 51860 - White
- Ref. 51861 - Chrome



#### DOUBLE HOOK

- Ref. 51862 - White
- Ref. 51863 - Chrome



#### TRIPLE HOOK

- Ref. 51864 - White
- Ref. 51865 - Chrome



## ECLUSE



#### SHOWER HOSE

- AISI 304 stainless steel (18/10)  
- Universal connectors  
- Length: 2 metres

- Ref. 51629 - Stainless steel

#### SHOWER MAT

- Translucent anti-bacterial PVC  
- Non-slip  
- Sticks to the bottom of the shower via a suction system

- Ref. 51165 - 54 x 54 cm
- Ref. 51166 - 35 x 70 cm



#### SHOWER HEAD

- Chrome ABS  
- Anti-scale elastomer nozzles

- Ref. 51624 - Chrome

## ORA UNBREAKABLE

### MIRROR

- Acrylic  
- Rounded edges  
- Pre-drilled mirror with 4 holes and self-adhesive strips on the back

- Ref. 51513 - Rectangular - 600 x 400 mm
- Ref. 51512 - Square - 600 x 600 mm
- Ref. 51511 - Round - Ø600 mm



## SANEA

- Chrome-plated steel  
- 2 anchoring points  
- Screws supplied

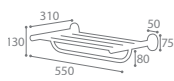

#### BATHROOM LINEN HOLDER - 55 CM

- Ref. 51613 - Chrome



#### SINGLE HOOK

- Ref. 51752 - Chromium-plated steel



#### DOUBLE HOOK

- Ref. 51710 - Chrome



#### TOWEL HOLDER 1 RAIL - 57.8CM

- Ref. 51507 - Chrome



#### SOAP HOLDER - 13.2 CM

- Ref. 51615 - Chrome



#### TOILET PAPER HOLDER

- Ref. 51781 - Chromium-plated steel

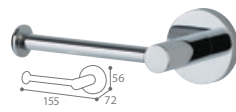

#### TOILET PAPER HOLDER

- Ref. 51717 - Chrome



#### TOILET PAPER HOLDER WITHOUT COVER

- Ref. 51900 - Chrome



## SANIPLA

- Polypropylene  
- Screws supplied

#### WASHHAND BASIN SHELF

- Ref. 51770 - White



#### TOWEL HOLDER

- Ref. 51731 - White

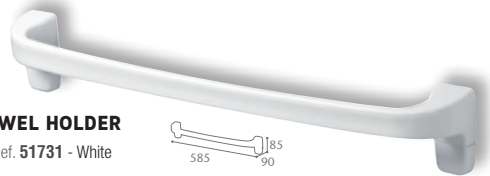

#### TRIPLE HOOK

- Ref. 51701 - White

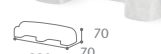

#### WALL-MOUNTED SOAP HOLDER

- Ref. 51760 - White



#### TOILET PAPER HOLDER

- Ref. 51780 - White





Hygiene

Insect killers



# Kileo



Chain for ceiling-mounting

- + VERY LONG LIFE LED TUBE
- + LOW ENERGY CONSUMPTION



### KILEO

#### ELECTRIFIED GRID INSECT KILLER - 40 W

- Polished stainless steel
- Suspended or free-standing
- On/Off switch on the side
- Electrical protection CL I – IP21

■ Ref. 51441 - 40 W - Range 150 m<sup>2</sup>



Removable pan

#### CONSUMABLES

##### KILEO

#### PACK OF 4 SHATTER-PROOF FLUORESCENT TUBES + STARTERS

- Lifespan: around 8,000 hours
- Consumable for the electrified grille insect killer 40W (Ref. 51441)

Ref. 51520 - 20 W - Shatter-proof - 4 tubes + 4 starters



### KILEO

#### INSECT KILLER WITH AN ELECTRIFIED LED GRILL - 13 W / 20 W

- Aluminium and plastic
- Hanging bracket (clips or free-standing)
- On/Off switch on the side
- Electrical protection CL I – IPX0

■ Ref. 51488 - 13 W - Range 80 m<sup>2</sup>  
 ■ Ref. 51489 - 20 W - Range 150 m<sup>2</sup>

Open on both sides for optimal efficiency

Removable pan

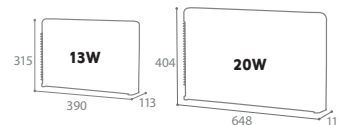

#### CONSUMABLES

##### KILEO

#### PACK OF 4 LED TUBES

- Lifespan: around 15000 hours
- Consumable for insect killers (Ref. 51488 and 51489)

Ref. 51486 - 6.5 W - 4 LED tubes  
 Ref. 51487 - 10 W - 4 LED tubes





# Kileo



Carrying handle

## ELECTRIFIED GRID INSECT KILLER - 11 W

- ABS plastic, fire-resistant
- Free-standing
- Side switch
- Electrical protection CL II – IPX2
- Mains connection

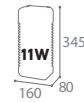

Ref. 51440 - 11W - Range 80 m<sup>2</sup>



## CONSUMABLES

### KILEO

#### COMPACT FLUORESCENT TUBE

- Lifespan: 8,000 hours
- Consumable for the compact insect killer (Ref. 51440)

Ref. 51528 - 11 W - per unit

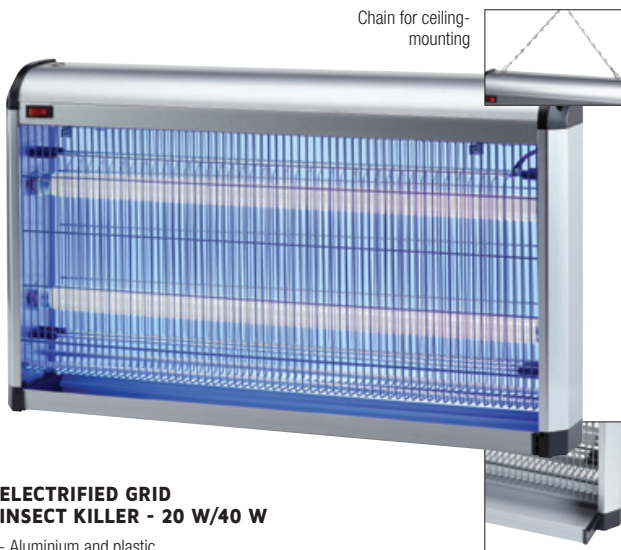

Chain for ceiling-mounting

## ELECTRIFIED GRID INSECT KILLER - 20 W/40 W

- Aluminium and plastic
- Suspended or free-standing
- On/Off switch on the front
- Electrical protection CL I - IP21

- Ref. 51536 - 20 W - Range 100 m<sup>2</sup>
- Ref. 51538 - 40 W - Range 150 m<sup>2</sup>

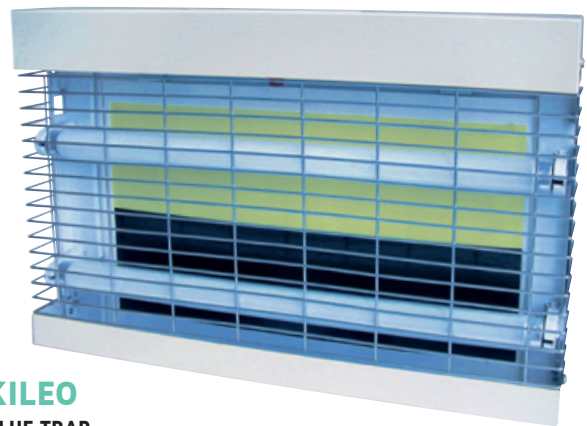
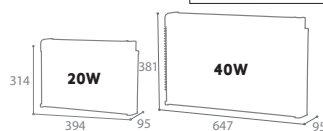

## KILEO

### GLUE TRAP INSECT KILLER - 30 W

- Anti-UV powder-coated steel
- Wall mounting with plate or suspension with chain
- Glueboard captures insects
- Electrical protection CL I - IPX0 - Mains connection
- **HACCP compliant**

□ Ref. 51490 - 30 W - Range 100 m<sup>2</sup>

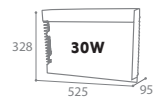

## CONSUMABLES

### KILEO

#### PACK OF 4 SHATTER-PROOF FLUORESCENT TUBES + STARTERS

- Lifespan: around 8,000 hours
- Consumable for the electrified grid insect killer 20 W (Ref. 51536) and 40W (Ref. 51441 and 51538)

Ref. 51519 - 10 W - Shatter-proof - 4 tubes + 4 starters  
Ref. 51520 - 20 W - Shatter-proof - 4 tubes + 4 starters



## CONSUMABLES

### KILEO

#### PACK OF 5 SHATTER-PROOF FLUORESCENT TUBES + STARTERS

- Lifespan: around 8,000 hours
- Consumable for the glue trap insect killer 2x15W (Ref 51490)

Ref. 51492 - 15 W - Shatter-proof - 5 tubes + 5 starters - White

#### PACK OF 5 GLUEBOARDS

- Glueboard for trapping insects
- Consumable for the glue trap insect killer (Ref 51490)

Ref. 51491 - Pack of 5

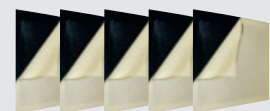
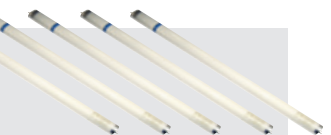

# Regulatory standards and certifications



## AGEC LAW

(ANTI-WASTE FOR A CIRCULAR ECONOMY)

► **Law no. 2020-105-10 February 2020:** TLaw N° 2020-105 10 February 2020: This legislation, in effect since Jan 1st 2020, will run until 2024 to modify in depth the methods of production, distribution and consumption. It aims to transform our linear economy (produce, consume, dispose) into a circular economy.

**It is broken down into 5 main areas:**

- Take out single use plastic
- Better information for consumers
- Fight against waste and encourage re-use
- Act against planned obsolescence
- Produce better

> See p10-36



## WASTE SORTING

Article 88 of the AGEC law 2024, concerning the sorting of food waste at source!

In order to implement the sorting of **household food waste** at source throughout France by 1 January 2024, it is up to each local authority to study and identify the most relevant solutions to sort food waste at source and ensure that it can be recovered and not landfilled. Separate collection of food waste by local authorities is complementary to local composting.

► The law of **12 July 2010**, known as the Grenelle 2 law, introduced an obligation for large producers to sort at source and recover biowaste and waste oils.

Since **1 January 2016**, producers of more than 10 tonnes of biowaste and 60 litres of waste oils per year have been concerned.

► The Act of **10 February 2020** on the fight against waste and the circular economy amended Article L. 541-21-1 of the Environmental Code by specifying that from **1 January 2023**, this obligation applies to persons who produce or hold more than five tonnes of bio-waste per year. From **1 January 2024**, all biowaste and waste oils must be collected separately for recovery.

> See p21, 22, 26, 27, 53

## OFG (Origine France Garantie) (GUARANTEE OF FRENCH ORIGIN)

The Origine France Garantie (OFG) label was officially presented to the National Assembly on 19 May 2011. The OFG certification is based on a fully-fledged certification process. Certification is done by authorised organizations. To obtain OFG certification, 2 cumulative criteria are mandatory: the place from where the product gets its essential characteristics is located in France and at least 50% of the unit cost price is acquired in France. The label allows companies to promote the product in France and consumers to choose to buy French.

> See p2-10 à 13-22-26-27-32-38 à 40-45-84



## WASTE SORTING

► **Act of 15/07/1975: first act organising the collection and treatment of waste in France.** Waste collection, transport and treatment operations must be carried out under clean conditions in order to avoid "any risk to the environment and human health". This act establishes the founding principle of "polluter pays".

► Law of 13/07/1992: also known as the Royal Act. It aims to reinforce the provisions of the 1975 act and requires companies to recycle their waste. Since 1992, waste has been a source of energy and raw materials that we are no longer allowed to throw away or destroy.

► **Law of 12/07/2010** makes it compulsory for major producers to set up waste sorting and collection of biowaste and edible oil waste (threshold for the application of the Decree in 2016: 10 tonnes per annum of biowaste, 60 L of edible oils).

► **Article L 541-2 of the Environment Code:** each company is responsible for the management of the waste it produces even when it is transferred to a third party for treatment. The company must ensure that its disposal process complies with regulations.

► **Decree no. 2016-288 of 10/03/2016:** It is the duty of each company to sort its paper, metal, plastic, glass and wood waste better so that it may be reused or recycled. Companies must separate these materials from other waste either by having a system at source or by using an automatic sorting system with a third party.

► **From 1 January 2022:** all paper and packaging, whether plastic, metal or cardboard, may be placed in the yellow bins and containers. This new directive will make it possible to reduce the tonnage of household waste produced each year in France, while achieving better recycling of the waste collected.

> **Need for waste sorting equipment. See p10-36**

► **On 1 January 2025:** the obligation to stream waste will be extended to all public spaces: streets, squares, gardens, beaches, etc. Local authorities will thus be obliged to replace street bins with recycling bins enabling the sorting of packaging and paper. These measures are aimed at speeding up the recovery and recycling of packaging "outside the home".

## ★★★ CLASSIFICATION OF TOURIST ACCOMMODATION

► **Order of 29/12/21 - published in the "Journal Officiel" on January 14th 2022.**

Since the 1st of April 2022, a new classification of Tourist Accommodation has come into force. It details the criteria setting the standards and classification procedure for tourist accommodation. The "accessibility and sustainable development" section of the previous classification has been strengthened, and the new criteria on the reduction of waste at source and waste sorting have been introduced (sorting in guest bedrooms, in common areas, in maintenance areas...). Rossignol helps tourist accommodations to meet these new criteria with the appropriate equipment: • Point 88: waste paper baskets, • Point 127: pedal bins, Point 130: clothes hooks, Point 135: bicycle racks, • Point 173: first aid boxes and equipment, • Point 229 and 230: waste reduction of products incorporating bulk refilling systems (soap, shower gel dispensers, etc), • Point 232: Indoor sorting bins including bio-waste, and/or outdoor if the establishment has outdoor areas, • Point 233: signage products associated to sorting (signage plates, stickers, ...)



# Regulatory standards and certifications



## VIGIPRATE NATIONAL SECURITY ALERT SYSTEM

The Vigipirate alert system is a French security measure intended to prevent threats or to react to terrorist actions that was created in 1978 and that is regularly updated. The objective is twofold: **protect people, infrastructures and institutions and prepare responses in case of attack.**



### The Vigipirate measure includes 3 levels:

- CONSTANT VIGILANCE in the face of a persistently high but widespread threat
- INCREASED SECURITY RISK OF ATTACK - Enhanced protection in the face of a high level of threat
- ATTACK EMERGENCY - Enhanced protection in the face of a documented and imminent threat of terrorist attack or in the immediate aftermath of an attack

Rossignol helps Local Authorities with the implementation of the first level of the Vigipirate measure (Vigilance). Our specially designed products enable the introduction or strengthening of suitable precautionary and protective measures.

► **Techniques for the accessibility of roads and public spaces :** BOLLARDS AND BARRIERS: allow the separation of traffic lanes, protection of pedestrian areas and the control of access by vehicles.

The minimum width and diameter of the obstacle decreases as its height increases in accordance with the chart.

The principle is that a small height of the post is compensated for by a large diameter and, conversely, that a small diameter is compensated by a high height of the street furniture.

> **Bag holders, bins with laser cut-outs, transparent bins, bins which can be blocked off.** See p3-6-12-15-19-26-27-28-29-32-36-44-45-46-48-49-50



## COMPACT LAMINATE (HPL)

### ► COMPACT CE CERTIFIED 'EN 438'

The compact laminate used complies with the requirements of the "external compact laminate" standard, for ageing tests, resistance to UV rays (1,500 h) and to artificial ageing (3,000 h). Compact PEFC certified panels. > See p38-39



## HIGH VISIBILITY BOLLARDS

► **Decree of 18 September 2012 amending the Decree of 15 January 2007 on technical requirements for the accessibility of roads and public spaces.**

> **Need for a base unit installed at a maximum of 0.40 metres above the ground.** - See p41

The contrasting colour part of a post shall consist of a strip at least 10 cm high [...] at a height between 1.20 and 1.40 m.

- easily identifiable: visual detection is one of the essential characteristics of the PRM bollard. It is important to make the bollard visible
- minimum dimensions for optimal detection: the dimensions allow the visually impaired to easily detect them using their cane. > See p37



## BARRIERS

► **Decree of 1/08/2006 (accessibility of PRM)**

Depending on the height from which a pedestrian could fall, or whether or not the user is visually impaired, barriers should be installed along the path where such a risk exists.

> See p42



## LEGISLATION ON PESTS

**The circular of 9 August 1978 (Articles 125.1 and 130.5)** requires protection against pests, including rodents. This obligation applies to both individuals and Local Authorities, who must not allow rodents to multiply.

**Article 17 of the ministerial decree of 9 May 1995** lays down the rules for establishments supplying food to consumers. They are obliged to draw up a plan for the eradication of pests in the event of the detection of a pest, by putting precise specifications in place

Failure to comply with this provision renders the person(s) concerned liable to penalties in the order of a third class fine. Pest control is mandatory for all owners according to Decree 2003-462 of 21 May 2003.

### We can identify 3 rules:

- Everyone must avoid the accumulation of waste so as not to attract rodents.
- Regular checks must be carried out to check that pests have not taken up residence on the premises.
- In the event of a confirmed infestation, the main actors must take the necessary measures to eradicate the pests and disinfect the premises.

> See. p28-29-44 à 46



## WASTE CONTAINERS

► **The safety/security of wheeled waste containers is subject to the provisions of standards NF-EN 840 1-6:**

- 1 to 4: Standards in relation to the dimensions
- 5 and 5/A1: Performance requirements and test methods
- 6 and 6/A1: Hygiene and safety requirements

> See p52-53



## SOFTWOOD CERTIFIED "CLASS 4"

► **Decrees of 05/04/05, all our wood products comply with the French ministerial directive on the promotion of sustainable forest management.**

The treatment system is known as autoclave, arsenic-free, in accordance with new European environmental directives. The treatment impregnates the wood to the core, making it rot-proof: resistant to rotting, insects and fungi. It gives the wood a slightly greenish colour that fades with time.

> see p58-59



## DOG HYGIENE

In France dog waste is permitted only in kerbside gutters with the exception of those parts within pedestrian crossings.

**All dog owners or guardians are obliged to immediately pick up dog waste by any appropriate means.**

This obligation is part of the new Criminal Code (Article R.632-1): "A second class fine is imposed for depositing, abandoning or throwing in a public or private place, with the exception of the places designated for this purpose by the competent administrative authority, rubbish, waste, materials or any other object of any kind whatsoever, if such deposit is not made by the person having the enjoyment of the place or with this person's authorisation ...".

In the event of failure to respect this provision, **the offence can lead to a second class fine** the amount of which varies according to the Local Authority or region.

> See p56-57



# Regulatory standards and certifications



## SMOKING BAN

### ► Decree No. 2006-1386 of 15/11/06

Since the 1<sup>st</sup> of February 2007, the smoking ban applies to businesses, government buildings, schools and health facilities.

Since 1 January 2008, it applies to so-called "meeting" places (cafés, hotels, restaurants, nightclubs, casinos). > See p64-68



## FEMININE HYGIENE PERIOD POVERTY

### Feminine hygiene

Environmental regulations on the disposal of blood waste

► **Article R232-5 to R. 232-5-9:** Toilets must be designed so as not to give off any odour, be equipped with flushing facilities and be equipped with toilet paper... Toilets reserved for women must have a receptacle for sanitary towels.

► **Article R4228-10:** In establishments employing mixed staff, toilets must be separate for female and male staff. Women's toilets must have a container for sanitary towels.

### Combating period poverty:

The Government is taking concrete action against student poverty by gradually making the protections they need throughout the year accessible to all female students, free of charge.

### This was done in stages:

- The CROUS university residences and university health services must be equipped with dispensers to dispense free environmentally friendly sanitary products.

- Since the start of September 2021, these dispensers must be in place throughout all university campuses.

> See p92-93



## CONTACT WITH FOODSTUFFS

### ► Framework Regulation (EC) no. 1935/2004/EC, Regulation (EC) no. 2023/2006 and other applicable European and national texts:

The material and/or article complies with the relevant requirements of, listed below:

- Concerning plastics intended for contact with food, Regulation (EU) no. 10/2011. It guarantees that the object and materials it is made up of do not pose any toxicity risks when in contact with food or drinks. Good hygiene practices require this type of item to be inert in contact with food, to prevent any migration of products and without catalytic effect that may alter the taste or quality of the foodstuff.

- If recycled materials are present in plastic materials and objects, Regulation (EC) no. 282/2008 ("Green" range) applies. > See p25-77



## HACCP (HAZARD ANALYSIS CRITICAL CONTROL POINT)

### ► Regulation (EC) no. 852/2004 of the European Parliament and of the Council dated 29 April 2004 – regulation entered into force on 1 January 2006

Food waste, inedible by-products and other waste shall be deposited in closed containers, unless food business operators can demonstrate to the competent authority that other types of containers or disposal systems are suitable. These must be properly designed, well maintained and easy to clean and, where necessary, be disinfected. This regulation identifies the following obligations for the waste part: collectors with a closing device, easy to maintain, disinfect and clean, appropriately designed.

To meet these regulatory obligations: collectors equipped with a lid, collectors with shapes facilitating cleaning and flow after rinsing, collectors that facilitate sorting via the available colours, and that do not exacerbate the risk of cross-contamination thanks to the pedal for opening the lid.

> **Need to be equipped with collectors that are easy to clean, the need for a pedal and a lid. See p23 à 25-76-77-95-96-107**



## ACCESSIBILITY FOR PERSONS WITH REDUCED MOBILITY

► **Decree of 1 August 2006** - All establishments open to the public and facilities open to the public must be accessible to PRM (People with Reduced Mobility) from 1 January 2015.

> **Requirement for equipment to meet all the needs and obligations in the field of accessibility and autonomy in relation to external accesses, including sanitary blocks. > See p104**

► **Decree of 18 September 2012 amending the Decree of 15 January 2007 on technical requirements for the accessibility of roads and public spaces.**

### ► Decree of 15 January 2007

Urban equipment and furniture present on footpaths must be of a minimum volume to make them be detectable and ensure the safety of the blind and the visually impaired.

> **Need for a base unit installed at a maximum of 0.40 metres above the ground. - See p34-41**



## SELF-EXTINGUISHING PRINCIPLE



► **Technical evaluation carried out by the CNPP (National Centre for Prevention and Protection):** product complies with the technical specifications.

CNPP: a certification body in the fields of fire prevention and protection drawing on the expertise of its laboratories and inspection and audit services.

> See p70-79



## FIRST AID

### ► Article R4224-14 – Decree no. 2008-244 of 7 March 2008

Decree no. 2008-244 of 7 March 2008 concerning the Labour Code contains three basic articles: Article R4224-14 of the Labour Code lays down that "workplaces must be equipped with first-aid equipment that corresponds to the nature of the risks and that is easily accessible". The employer must take the necessary measures to ensure the safety and protect the physical and mental health of workers within its premises.

> See p81-82



## AD'AP MEASURE

► **Decree of 14 September 2018 on monitoring the progress of scheduled accessibility agendas - JORF no. 0234 of 10 October 2018 - Entry into force: 10 January 2019**

Modalities for monitoring the progress of Scheduled Accessibility Agendas (Ad'AP) for the accessibility of establishments open to the public (ERP) and facilities open to the public (IOP).

The decree defines the minimum content of the status reports at the end of the first year and the reviews of the work and other accessibility actions carried out halfway through the duration of the scheduled accessibility agenda.

> See P35-104





# Warranties & Maintenance



## PRODUCT WARRANTIES

**ROSSIGNOL guarantees all products listed in the 2024 catalogue and marketed under this brand name against all defects or faults in design, manufacture and materials.**



All the products in the catalogue come with a 2-year warranty unless stipulated otherwise.

It is recalled that the statutory warranty for hidden defects applies in accordance with the statutory provisions.



Products guaranteed for 5 years or 2 years in saline environments.

## Warranty exclusions

The warranty does not cover defects resulting from handling, transport and installation.

The warranty is not applicable if the products are not used according to generally accepted practices or in the case of abnormal or improper use of the products.

### The contractual warranty does not cover in addition:

- ❑ Defects and their consequences due to improper use other than what it was intended for.
- ❑ Defects and their consequences due to factors outside our control.
- ❑ Defects due to absence or lack of maintenance.
- ❑ Defects due to vandalism.

In all cases, the warranty is limited to the defects on the products and not to the consequences of these defects, for which no compensation is payable.

\*Subject to compliance with installation and maintenance guidelines.



## CARE INSTRUCTIONS

**Our products are guaranteed subject to compliance with installation and maintenance guidelines. ROSSIGNOL advises you to care for your products on a regular basis in order to protect them against wear and tear. The validity of the Rossignol warranty is subject to the proper application of these recommendations.**



### STEEL

The various treatments applied to the steel (primer, hot-dip galvanising, etc.) extend its lifetime and make it resistant to heat, cold and corrosion. The ideal way to clean it is with soap and water.

**Chlorinated products, hydrocarbons and abrasives should be avoided:** any use of such products may invalidate the application of the product warranty. The warranty does not apply to any alteration by scratches or blows.

The installation of steel products is not suitable in chlorinated environments (e.g. swimming pools).



### ALUMINIUM

Aluminium is a material that is easy to maintain. The ideal way to clean it is with soap and water. N.B.: Chlorinated products, hydrocarbons and abrasives should be avoided: any use of such products may invalidate the application of the product warranty.



### SOFTWOOD CERTIFIED "CLASS 4"

The treatment system is known as autoclave, arsenic-free, in accordance with new European environmental directives. The treatment impregnates the wood to the core, making it rot-proof: resistant to rotting, insects and fungi. It gives the wood a slightly greenish colour that fades with time.

It is recalled that the durability and aesthetic appearance of the wood require regular maintenance, the frequency of which depends on the site and climatic conditions (at least every six months). The customer expressly undertakes to provide proof of such maintenance in the event of a warranty claim.



### RECYCLED SLATS

This material is the easiest to maintain: simply clean with soap and water.

No high-pressure cleaner : even at low pressure, it will damage the protective layer more quickly.

No bleach: even if well rinsed, bleach leaves black marks under the effect of the sun.



### STAINLESS STEEL

A soft cloth or sponge, along with a mild detergent is enough to obtain a perfect result. For brushed surfaces, rub in the direction of the grain. Always wipe the products dry as soon as they are washed. In case of pitting on the surface, the product can be treated with a passivator suitable for stainless steel. The warranty does not apply to pitting of the surface by corrosion points due to lack of maintenance and requiring cleaning with a passivating stripper. The installation of stainless steel products is not suitable in chlorinated environments (e.g. swimming pools).



### HIGH PRESSURE LAMINATE (HPL)

The compact laminate panel (HPL) is the material of excellence for combining durability, maintenance, aesthetics and environmental aspects. UV radiation, bad weather, shock, scratches, abrasion, and burns... nothing stands up to HPL.

**THE PLUS:** It is an anti-graffiti material that leaves no residue or traces.

Maintenance instructions: Clean with fresh water using a sponge, finish with a soft cloth.

If stains persist, use acetone or white spirit on a perfectly clean soft cloth. Rinse with warm water and finish with a soft cloth.



### PLASTIC

This material is the easiest to maintain: simply clean with soap and water.

**NO HIGH-PRESSURE CLEANER :** even at low pressure, it damages the protective layer more quickly.

**OR BLEACH:** even if well rinsed, bleach leaves black marks under the effect of the sun.

**POLYETHYLENE - PE:** Rigid plastic with excellent chemical and impact resistance.

**POLYPROPYLENE - PP:** Rigid plastic particularly resistant to outdoor and wet conditions.

**RECYCLED POLYETHYLENE:** Plastic resistant to water, chemicals, chipping, cracking and delamination.

**RECYCLED POLYPROPYLENE** Water, corrosion, chemical, shock and heat resistant plastic up to 100°C.



### CONCRETE

Concrete is most often a single-piece material. It is easy to install on a surface that has been cleaned and cleared. It is highly resistant to temperature variations, bad weather but also to impacts and vandalism.

it is easy to maintain: just use soapy water or PH neutral products only.

An anti-graffiti treatment can be added (subject to quotation - please contact us).

Do not use high pressure cleaners.





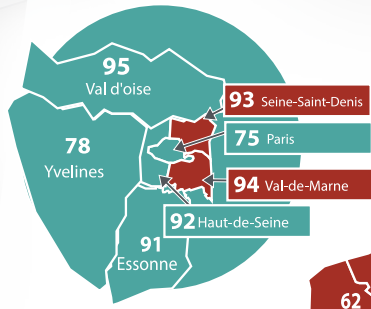

**BELGIUM • NETHERLANDS  
LUXEMBOURG • SWITZERLAND**

Tel: +33 (0)2 43 01 55 55  
 export@rossignol.fr



**GERMANY  
AUSTRIA**

Tel: +33 (0)6 31 43 55 55  
 deutschland.pro@rossignol.fr

**Secteur Nord-Ouest**  
 iledefrance.pro@rossignol.fr  
 06 16 39 11 27

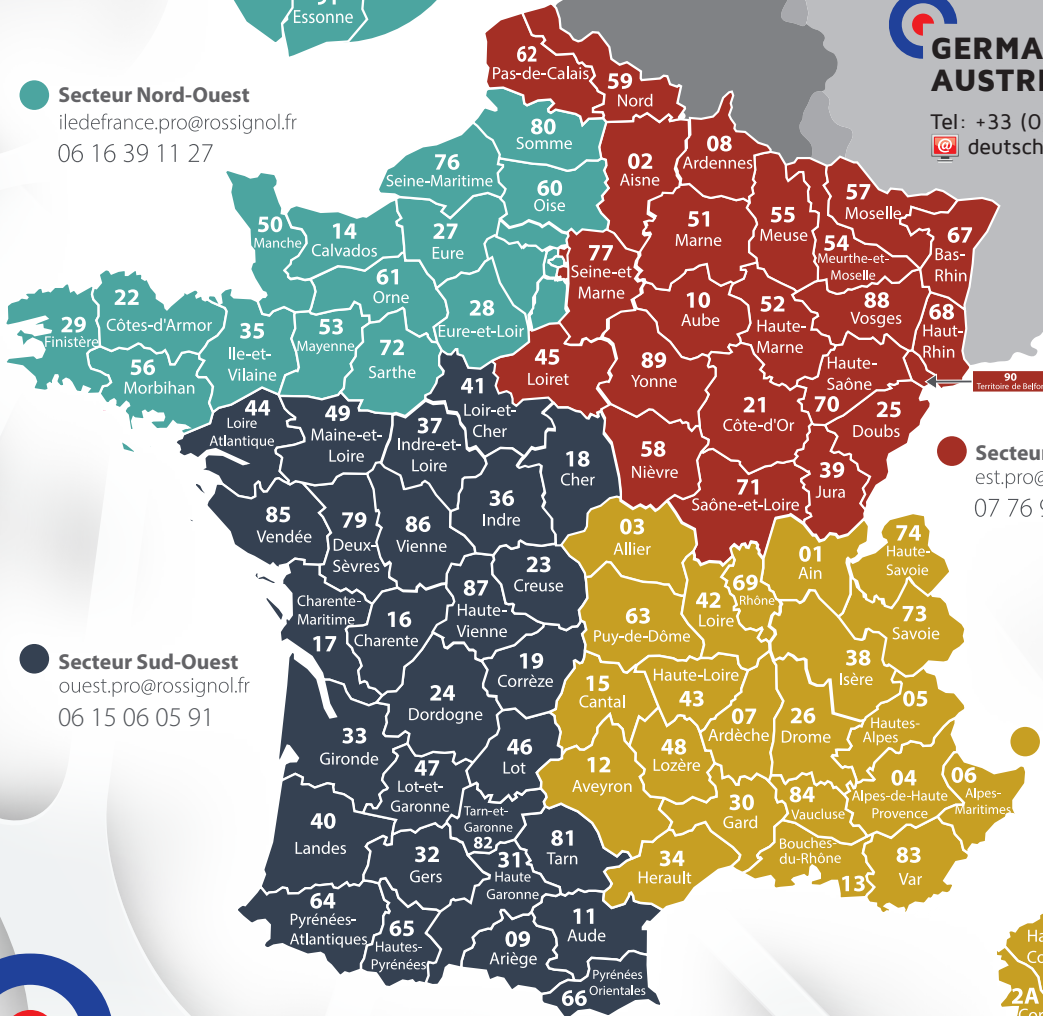

**Secteur Nord-Est**  
 est.pro@rossignol.fr  
 07 76 93 63 07

**Secteur Sud-Ouest**  
 ouest.pro@rossignol.fr  
 06 15 06 05 91

**Secteur Sud-Est**  
 sud.pro@rossignol.fr  
 06 16 39 11 36



**SALES DEPARTMENT  
FRANCE**

Tel: 02 43 01 55 55  
 contact@rossignol.fr



**SALES DEPARTMENT  
EXPORT**

Tel: +33 (0)2 43 01 55 55  
 export@rossignol.fr

ROSSIGNOL® - © Copyright brand and models registered 2024-2025 - 1900624 - Created, produced and Printed by EGIDIUS Conseil (63)

**ROSSIGNOL®**  
 PRO

Route de Saint Cénére - 53150 Montsûrs - FRANCE  
 Tel. +33 (0)2 43 01 55 55  
 export@rossignol.fr

[www.rossignol.fr](http://www.rossignol.fr)

Your distributor-consultant



3 019926 037615